

aiwa

DVD Stereo System

XR-DV700
U



For assistance and information

call toll free 1-800-BUY-AIWA
(United States and Puerto Rico)

8B-CQA-903-01
010420ACK-U-M

U-006-640-7U

En (English)

—— OPERATING INSTRUCTIONS

PRECAUTION

Read these Operating Instructions carefully and completely before operating the unit. All precautions on this booklet and on the unit should be strictly followed. Keep the Operating Instructions for future reference.

WARNING

To reduce the risk of fire or electric shock, do not expose this appliance to rain or moisture.

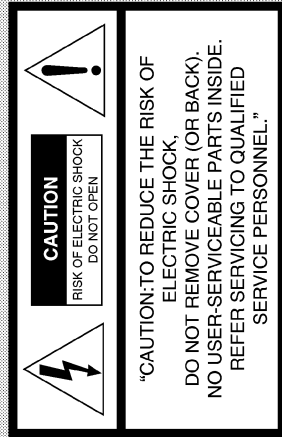

Explanation of Graphical Symbols:

The lightning flash with arrowhead symbol, within an equilateral triangle, is intended to alert the user to the presence of uninsulated "dangerous voltage" within the product's enclosure that may be of sufficient magnitude to constitute a risk of electric shock to persons.

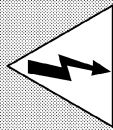

The exclamation point within an equilateral triangle is intended to alert the user to the presence of important operating and maintenance (servicing) instructions in the literature accompanying the appliance.

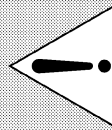

Warning

To prevent electric shock or injury, these safety instructions should be followed in the installation, use and servicing the unit.

Installation

Attachments — Do not use attachments not recommended by the unit manufacturer as they may result in the risk of fire, electric shock or injury to persons.

Water and Moisture — Do not use this unit near water — for example, near a bathtub, washbowl, kitchen sink, or laundry tub, in a wet basement, or near a swimming pool, and the like.

Heat — Do not use this unit near sources of heat, including heating vents, stoves, or other appliances that generate heat. It also should not be placed in temperatures less than 5°C (41°F) or greater than 35°C (95°F).

Mounting surface — Place the unit on a flat, even surface.

Accessories — Do not place this unit on an unstable cart, stand, tripod, bracket, or table. The unit may fall, causing serious injury to a child or an adult, and serious damage to the appliance. Use only with a cart, stand, tripod, bracket, or table recommended by the manufacturer, or sold with the unit. Any mounting of the appliance should follow the manufacturer's instructions, and should use a mounting accessory recommended by the manufacturer.

Portable cart — An appliance and cart PORTABLE CART combination should be moved with care. **WARNING**



S3125A

Quick stops, excessive force, and uneven surfaces may cause the appliance and cart combination to overturn.

Ventilation — The unit should be situated with adequate space around it so that proper heat ventilation is assured. Allow 15 cm clearance from the rear and the top of the unit, and 5 cm from the each side.

Slots and openings in the cabinet and the back or bottom are provided for ventilation, and to ensure reliable operation of the unit and to protect it from overheating, these openings must not be blocked or covered. The openings should never be blocked by placing the unit on a bed, sofa, rug or other similar surface. (This unit should never be placed near or over a radiator or heat register.) This unit should not be placed in a built-in installation such as a bookcase unless proper ventilation is provided.

Object and Liquid Entry — Never push objects of any kind into this unit through the cabinet slots as they may touch dangerous voltage points or short-circuit parts that could result in a fire or electric shock. Never spill liquid of any kind on the unit.

Wall or ceiling mounting — The unit should not be mounted on a wall or ceiling, unless specified in the Operating Instructions.

Electric Power

Power Sources — This unit should be operated only from the type of power source indicated on the marking label. If you are not sure of the type of power supply to your home, consult your appliance dealer or local power company. To operate unit on battery power, or other sources, refer to the operating instructions.

Grounding or Polarization — This unit is provided with a polarized alternating-current line plug (a plug having one blade wider than the other). This plug will fit into the power outlet only one way. This is a safety feature. If you are unable to insert the plug fully into the outlet, try reversing the plug. If the plug should still fail to fit, contact your electrician to replace your obsolete outlet. Do not defeat the safety purpose of the polarized plug.

Power-Cord Protection — Power-supply cords should be routed so that they are not likely to be walked on or pinched by items placed upon or against them, paying particular attention to cords at plugs, convenience receptacles, and the point where they exit from the product.

Overloading — Do not allow anything to rest on the power cord. Do not overload wall outlets and extension cords as this can result in fire or electric shock. Do not locate this unit where the cord will be abused by persons walking on it.

Outdoor Antenna

Power lines — An outside antenna system should not be located in the vicinity of overhead power lines or other electric light or power circuits, or where it can fall into such power lines or circuits. When installing an outside antenna system, extreme care should be taken to keep from touching such power lines or circuits as contact with them might be fatal.

Outdoor Antenna Grounding — If an outside antenna or cable system is connected to the unit, be sure the antenna or cable system is grounded so as to provide some protection against voltage surges and built-up static charges. Section 810 of the National Electrical Code, ANSI/NFPA No. 70, provides information with regard to proper grounding of the mast and supporting structure, grounding of the lead-in wire to an antenna discharge unit, size of grounding conductors, location of antenna-discharge unit, connection to grounding electrodes, and requirements for the grounding electrode. See the figure.

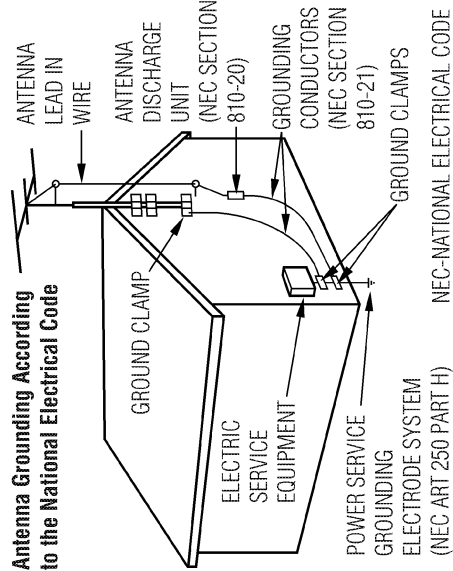

Lightning

For added protection for this unit receiver during a lightning storm, or when it is left unattended and unused for long periods of time, unplug it from the wall outlet and disconnect the antenna or cable system. This will prevent damage to the unit due to lightning and powerline surges.

Maintenance

Cleaning — Unplug this unit from the wall outlet before cleaning. Do not use liquid cleaners or aerosol cleaners. Use a damp cloth for cleaning.

Damage Requiring Service

Unplug this unit from the wall outlet and refer servicing to qualified service personnel under the following conditions:

- 1) When the power cord or plug is damaged or frayed.
- 2) If the liquid has been spilled into the unit.
- 3) If the unit has been exposed to rain or water.
- 4) If the unit does not operate normally by following the operating instructions. Adjust only those controls that are covered by the operating instructions as improper adjustment of other controls may result in damage and will often require extensive work by a qualified technician to restore the unit to normal operation.
- 5) If the unit has been dropped or the cabinet has been damaged.

6) When the unit exhibits a distinct change in performance - this indicates a need for service.

Do not attempt to service this unit yourself as opening or removing covers may expose you to dangerous voltage or other hazards. Refer all servicing to qualified service personnel.

Replacement Parts — When replacement parts are required, be sure the service technician has used replacement parts specified by the manufacturer or having the same characteristics as the original part. Unauthorized substitutions may result in fire, electric shock or other hazards.

Safety Check — Upon the completion of any service or repairs to this unit, ask the service technician to perform safety checks to determine that the unit is in proper operating condition.

TABLE OF CONTENTS

PRECAUTION 2

PREPARATION 5

PARTS AND CONTROLS 8

ADJUSTMENT BEFORE OPERATION 12

PLAYING DISCS

PREPARATORY INFORMATION 14

BASIC PLAYBACK 15

SELECTING TRACKS/CHAPTERS 17

OTHER PLAYBACK MODES 18

DVD FEATURES 20

STATUS DISPLAY 22

DOLBY AND DTS SURROUND 23

RADIO 25

SOUND 27

TIMER 28

EXTERNAL EQUIPMENT 30

CUSTOMIZING DVD SETUP 31

REFERENCE 38





OWNER'S RECORD

Record the model number and serial number of your set (found at the rear of your set) below. Refer to them when contacting your Aiwa dealer.

Model No. _____

Serial No. _____



As an ENERGY STAR® Partner, AIWA has determined that this product meets the ENERGY STAR® guidelines for energy efficiency.

System and accessories

- XR-DV700
 - CX-LDV700 DVD stereo system
 - SX-L700 Five Surround speaker system (front speakers, surround speakers, center speaker)
 - TS-LW700 Subwoofer
 - Remote control
 - Lithium battery (CR2025)
 - FM antenna, AM antenna
 - Connecting cord (DIN 8-pin)
 - Video connecting cord
 - Front speakers cord (approx. 4 m / 13 ft.) × 2
 - Surround speaker cord (with plugs, approx. 8 m / 26 ft.) × 2
- The red plug is for the right channel and the white plug is for the left channel.
- Center speaker cord (with an orange plug, approx. 3 m / 10 ft.) × 1
 - Pedestal × 2

PREPARATION

Placement

Place the speakers in their proper position. All speakers for a full 5.1-channel home theater come supplied with your DVD system.

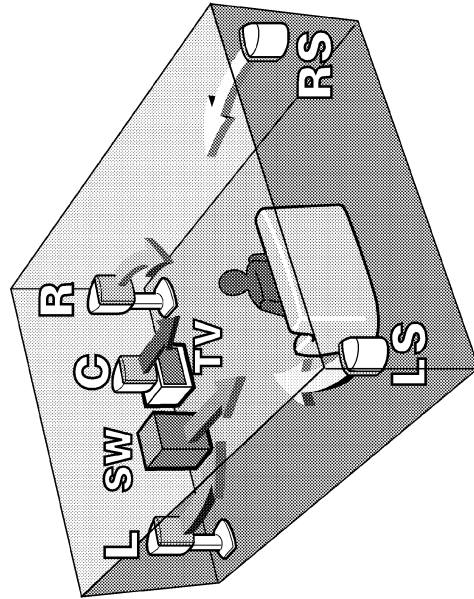

L&R: Front speakers (marked "FRONT")

C: Center speaker (marked "CENTER")

Place it in the center of the two front speakers, possibly on or below the TV set.

LS&RS: Surround speakers (marked "REAR")

Place them directly to the side of or slightly behind the listening area. Align them horizontally, preferably about 1 meter (3 feet) above ear height.

SW: Subwoofer

Place it on the floor close to a wall or in a corner of the room.

To attach the front speaker to the pedestal

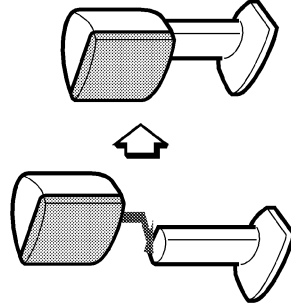

To place the main unit

Allow 15 cm (6 in.) clearance from the top of the unit for movement of the disc compartment lid.

To attach the anti-skid patches

To prevent the surround and center speakers from slipping, attach the supplied anti-skid patches to the bottom of the speakers. Use 3 patches for each of these speakers.

En

To mount the surround speakers on the wall

Mount each speaker on a spot that can hold its weight.

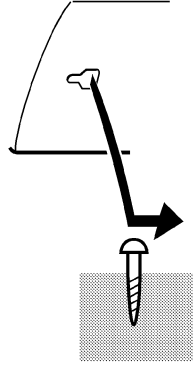

AIWA disclaims any responsibility for injury to persons or other accidents caused by not fitting the surround speakers properly or if the place of the installation is not suitable.

- Either of the two front speakers can be used as the right or the left one; likewise for the surround speakers.
- Do not place the left and right front speakers close to the TV set, as doing so may cause picture noise.
- Sound output from the center and the surround speakers is only available when the Dolby or the DTS surround system is activated with the appropriate setting.

Connection

Plug in the AC power cord to the AC power outlet after all other connections are made.

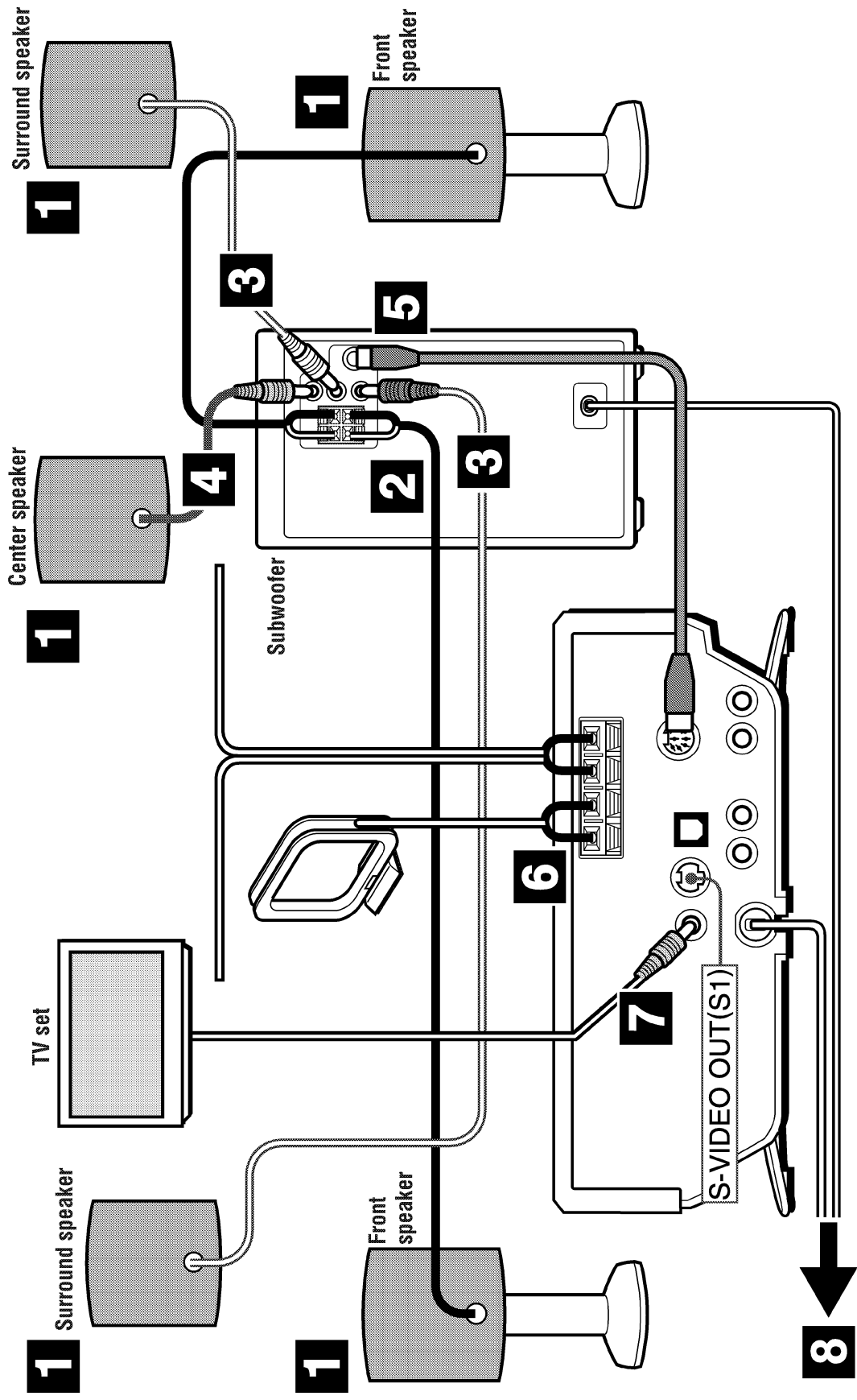

1 Connect the bare ends of each speaker cord to the corresponding speaker.

Be sure to use the correct cord for each speaker.

- Front speaker cords have bare leads at both ends (approx. 4 m / 13 ft).
 - Surround speaker cords are the longer cords with a plug at one end (approx. 8 m / 26 ft).
- The red plug is for the right channel and the white plug is for the left channel.

- Center speaker cord is the short cord with an orange plug at one end (approx. 3 m / 10 ft).

The copper-colored cords go to the \oplus terminal of each speaker.

2 Connect the cords from the front speakers to the appropriate terminals on the subwoofer.

- Right front speaker: FRONT R terminals
- Left front speaker: FRONT L terminals

The copper-colored cords go to the \oplus terminals.

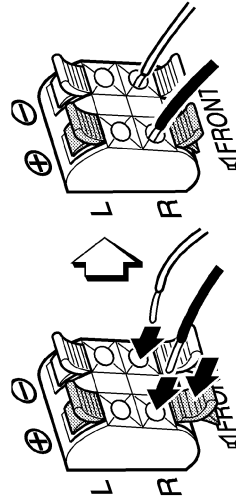

3 Connect the cords from the surround speakers to the appropriate jacks on the subwoofer.

- Right surround speaker: SURROUND R jack (red)
- Left surround speaker: SURROUND L jack (white)

4 Connect the cord from the center speaker to the CENTER jack (orange) on the subwoofer.

5 Connect the subwoofer to the main unit.

Connect the FROM CX-LDV700U jack of the subwoofer to the TO TS-LW700U jack with the supplied connecting cord (DIN 8-pin).

- Do not connect other equipment to the TO TS-LW700U jack because this is used exclusively for the supplied subwoofer.

6 Connect the supplied antennas.

Connect the FM antenna to the FM 75 Ω terminals and the AM antenna to the AM LOOP terminals.

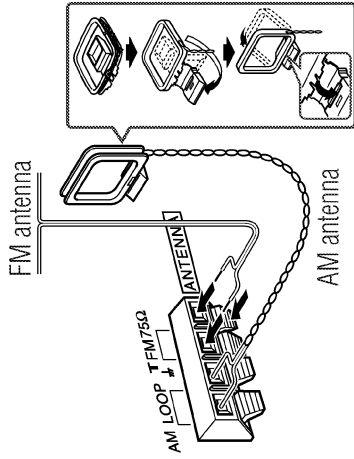

7 Connect the television set.

If your TV set has an S-video input jack:

Connect the S-VIDEO OUT (S1) jack of this unit and the S-video input jack of your TV with an optional S-video connecting cord.

If your TV set does not have an S-video input jack:

Connect the VIDEO OUT jack of this unit and the video input jack of your TV with the supplied video connecting cord (the one with plugs at both ends).

Refer also to the Operating Instructions of your TV set.

The illustration shows the connection to the VIDEO OUT jack.

- If your TV set is a wide-screen set: you need to adjust the TV aspect setting later (see "TV Aspect", page 33).
- Do not use more than one connection to connect your TV.

8 Connect the power supply.

Plug in the AC power cords of the main unit and the subwoofer to AC outlets.

The automatic demonstration will run on the display while the power is turned off.

To deactivate the automatic demonstration, press DEMO/ECO. The clock will flash on the display. For setting the clock, see page 13.

- Do not short-circuit the \oplus and \ominus speaker cord leads.
- Do not leave objects generating magnetism or objects affected by magnetism near the speakers.

Remote control

While sliding the latch, pull out the battery holder from the bottom of the remote control. Place the supplied battery on the battery holder with correct polarity. Finally, insert the holder back into position.

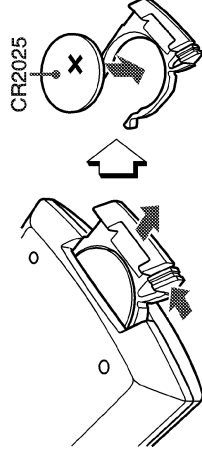

- Replace the battery with a new one when the operational distance between the remote control and main unit becomes shorter.
- Remove the battery if the unit is not going to be used for an extended period of time.
- The remote control may not operate if it is used under intense sunlight or if its line of sight is obstructed.

Caution!

- Do not keep the battery near metallic objects such as rings, bracelets, and keys. It may cause the battery to short circuit.
- After removing the battery, be sure to keep it out of reach of children. In case it is swallowed, consult a doctor immediately.

PARTS AND CONTROLS

Main unit: front

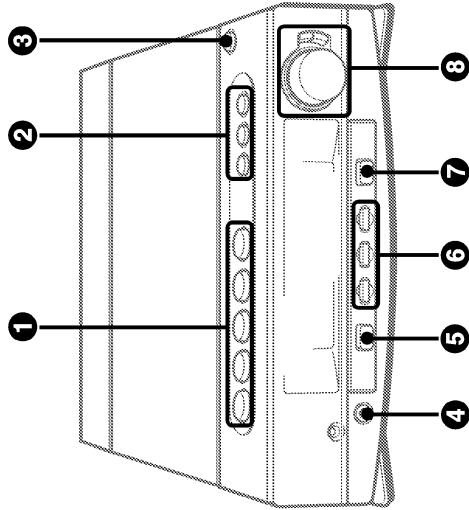

2 TUNER/BAND

Selects radio function and the radio band.

AUX

Selects AUX function.

DVD/CD

Selects DVD/CD function.

3 ▲ OPEN/CLOSE

Opens and closes the disc compartment.

4 PHONES jack

Plug in here an optional headphones set with a stereo mini plug (ø3.5 mm, 1/8 in.). Speaker output is canceled.

5 POWER ⏻ STANDBY/ON

Switches the unit on and off (standby).

6 DEMO/ECO

When the unit is turned off: selects ECO mode, DEMO mode or displays the clock.

When the unit is turned on: selects DEMO mode.

DISPLAY

Disc: displays the title/chapter/track number being played and remaining time of play.

Radio: displays the frequency of the tuned station.

COLOR

Selects the display color.

7 SURROUND

Turns on the Dolby or DTS decoder. Press repeatedly to select a listening mode.

8 VOLUME/MULTI JOG

Adjusts the volume.

Changes the menu item selection in the MODE setting.

MODE

Adjusts various mode and sound settings. Press repeatedly to select among T-BASS, BASS, TREBLE, SLEEP and TIMER.

ENTER

Enters the item selected with MULTI JOG.

1 I ISET

Disc: pauses playback.

Radio: stores the received station to preset.

■ CLEAR

Disc: stops playback.

Radio: clears a station preset.

▶ PRESET

Disc: starts playback.

Radio: tunes into a preset station.

◀◀ I◀◀ DOWN, ▶▶▶▶▶ HUP

Disc: skips to a previous or a succeeding chapter/track when pressed, searches a title/track in fast forward or fast reverse playback when held down.

Radio: manually tunes down or up within the band.

Main unit: rear

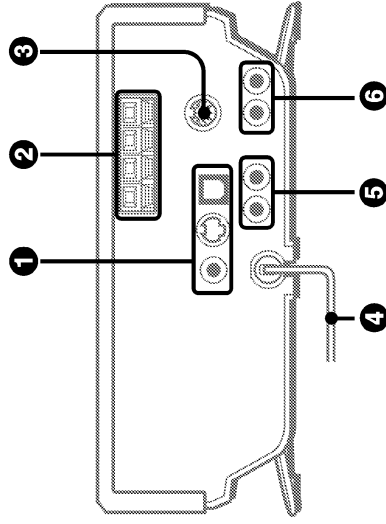

1 VIDEO OUT jack

Outputs standard (composite) video signals.

2 S-VIDEO OUT (S1) jack

Outputs S-VIDEO signals.

3 DIGITAL OUT (OPTICAL) jack

Outputs digital audio signals to external digital equipment. Keep the jack covered with the supplied dust cap when it is not being used.

CAUTION

NEVER play a multichannel Dolby Digital or a DTS source through external digital equipment without a Dolby Digital or a DTS decoder, respectively. Doing so will generate high level noise which may be harmful to your ears and damage the speakers.

Subwoofer

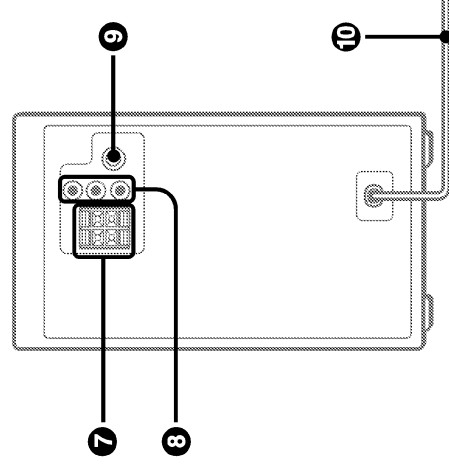

7 FRONT terminals

Connect the supplied front speakers here.

8 CENTER jack (orange)

Connect the center speaker here.

9 SURROUND jacks (red or white)

Connect the surround speakers here.

10 FROM CX-LDV700U jack

Connect the main unit here with the supplied connecting cord (DIN 8-pin).

AC power cord

Remote control

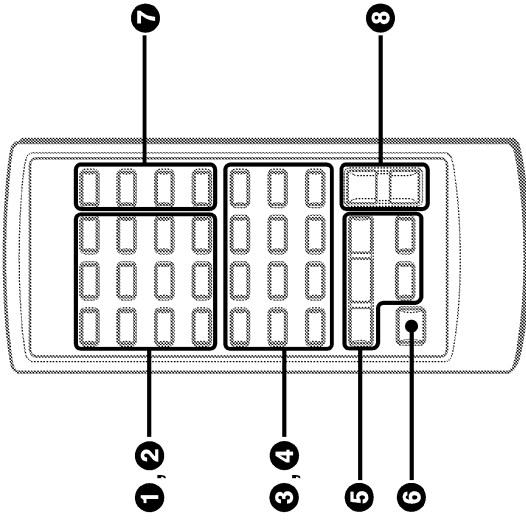

Buttons with same or similar names with the main unit basically have the same function.

1 0-9, +10

Disc: selects a title/chapter/track of the specified number.
 Selects a menu item for VCDs with PBC.
 Radio: tunes in to the station with the specified preset number.

C

Clears the Mark memory, etc.

2 The numbered buttons take on these functions when pressed together with SHIFT:

AUDIO SELECT

Changes audio tracks (DVDs) or channels (VCDs).

SUB TITLE SELECT

Changes the subtitle language (DVDs only).

SUB TITLE ON/OFF

Switches the subtitle on and off (DVDs only).

T-SEARCH

Enters the time search mode to locate a point in the disc by specifying the title number, chapter number or the playback time (DVDs only).

MARK

Enters the Mark mode to mark a point in the disc or to start playback from a marked point (DVDs only).

ANGLE

Selects the angle to view the scene (DVDs only).

REPEAT

Enters repeat playback mode.

RANDOM/PRGM

Enters random or programmed playback mode (CDs and VCDs).

PBC

Switches PBC(Playback Control) on and off for VCDs.

TIMER

Enters timer setting mode.

SLEEP

Enters sleep-timer setting mode.

CLOCK

Enters clock adjustment mode.

3 T-BASS

Emphasizes low frequency sound.

TITLE

Displays the title menu for DVDs.



Changes the menu item selection.

ENTER

Enter the selected item.

MENU

Displays the menu for DVDs.

SETUP

During stop: enters the setup menu.
 During playback: changes the playback time display of a disc.

SURROUND

RETURN

Returns to the previous menu screen. Displays the menu for VCDs.

SHIFT

Hold down when pressing a numbered button to change its function to that printed above the number.

- e.g., "Press **SHIFT+TIMER** on the remote control" means to hold down **SHIFT** and press **0/TIMER** to use the button for the timer function.

4 The following buttons take on these functions when pressed together with SHIFT:

MONO TUNER

Switches between stereo or monaural FM reception.

ZOOM

Enlarge the picture (DVDs only).

Display window

- CENTER(+, -)**
Adjusts the sound level of the center speaker for Dolby and DTS surround.
- REAR(+, -)**
Adjusts the sound level of the surround speakers for Dolby and DTS surround.
- MAN/SEL (Manual/Select)**
Enters speaker level and delay time setting mode.

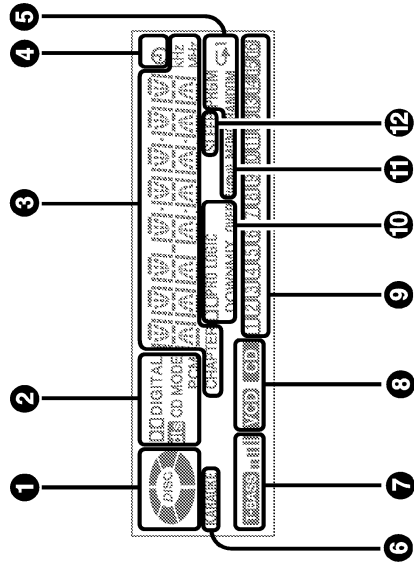

- 7 T-BASS level indicators**
Displays the T-BASS level.
- 8 Disc type indicators**
Indicates the type of current disc (CD or VCD).
- 9 Track/preset number indicator**
Displays the track number of CD or VCD and preset number of radio. The current track/preset number flashes.
- 10 Output type indicators**
The surround playback mode indicators ("DOWNMIX" and "DOLBY LOGIC") indicate the surround output type in which the source is actually being played. The "OVER" level indicator lights up when external input level from the AUX jacks is too high.
- 11 MONO/((∞)) (stereo) indicators**
Indicates the type of radio reception.
- 12 SLEEP indicator**
Lights up when the sleep function is active.

- 1 Disc indicators**
Rotates during playback. Lights up during stop. "DISC" lights up while the disc is loaded.
- 2 Audio signal type indicators**
Indicates the signal type of the current audio track.
- 3 Main display**
Shows general information such as the active function, current adjustment mode, title/chapter/track number, elapsed time, radio frequency, or the time.
- 4 Indicator**
Lights up when the timer function is active.
- 5 Playback mode indicators**
Lights up to show the programmed, repeat, and random playback modes.
- 6 KARAOKE indicator**
Lights up when playing Dolby Digital karaoke disc.

- 5 CENTER(+, -)**
Adjusts the sound level of the center speaker for Dolby and DTS surround.
- 6 REAR(+, -)**
Adjusts the sound level of the surround speakers for Dolby and DTS surround.
- 7 MAN/SEL (Manual/Select)**
Enters speaker level and delay time setting mode.
- 8 <</I<<DOWN**
- 9 >>/>>IUP**
- 10 ISET**
- 11 CLEAR**
- 12 POWER**
- 13 TUNER BAND**
- 14 AUX**
- 15 DVD/CD**
- 16 ON SCREEN DISPLAY**
Displays disc playback status on the TV screen.
- 17 VOLUME (∧, ∨)**

ADJUSTMENTS BEFORE OPERATION

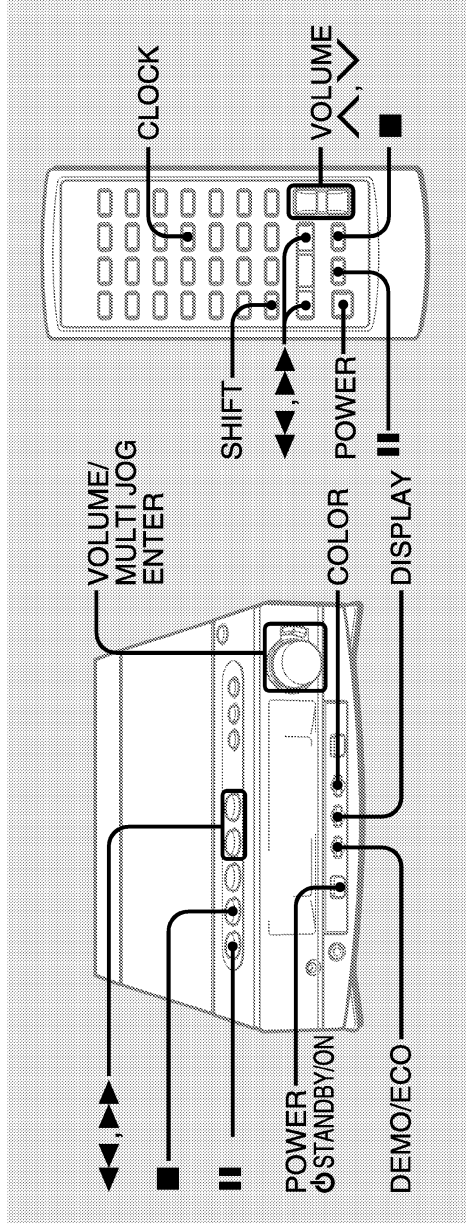

When power economizing mode is activated
When the unit turns off, "ECO MODE" is displayed for 4 seconds, and everything on the display clears. Only the red indicator on the POWER button lights to show that power is being supplied to the unit.

Standby power consumption
When power economizing mode is activated: 0.7 W
When power economizing mode is deactivated: 9 W

Power

Press POWER STANDBY/ON (POWER on the remote control) to turn the unit on and off.

Volume

Turn VOLUME/MULTI JOG, or press VOLUME on the remote control. Adjust from 0 (minimum) to 30 and MAX (maximum).

- Volume level setting is retained during power-off standby. If the unit is turned off with the volume set to 21 or more, it is automatically turned down to 20 the next time the unit is turned on.

DEMO

If the clock has not been set, "DEMO" appears on the display when the unit is turned off.

To deactivate the DEMO

While "DEMO" is displayed, press DEMO/ECO. The clock flashes. For setting the clock, see page 13.

ECO mode

Reduces power consumption with the following operations.

After clock is set, this unit allows you to regulate its power consumption by displaying nothing on the display while the power is off. **This is called power economizing mode.**

Press DEMO/ECO while the unit is turned off.

Each press of this button changes the display status as follows:

- ① Demo display (power economizing mode canceled)
 - ② Power economizing mode
 - ③ Clock display (power economizing mode canceled)
- Pressing or ENTER turns on the backlight for 4 seconds.

Changing the display color

The display color can be selected from among the preset colors (Select color mode). 12 type of colors has already preset and 5 type of colors can be adjusted to your taste. In addition, the display color can be selected for each function. (Function color mode).

Adjust the preset colors

- 1 Press COLOR to display "SEL-COLOR" while the power is on.
- 2 Within 4 seconds, turn VOLUME/MULTI JOG until "COLOR M 1" to "COLOR M 5" is displayed.
- 3 Within 4 seconds, press COLOR.
"50_50_50" is displayed and the left "50" flashes.
- 4 Press DISPLAY repeatedly to select the color to be adjusted.
 - Left "50": adjust amber color.
 - Center "50": adjust green color.
 - Right "50": adjust blue color.The selected item flashes.
- 5 Turn VOLUME/MULTI JOG to adjust the color.
The level can be adjusted from "00" to "50". "50" is the brightest level.
- 6 Repeat steps 4 and 5 to set the desired color.
- 7 Press ENTER.
"SET-COLOR" is displayed.

- If power is interrupted for more than approximately 12 hours, all settings stored in memory after purchase need to be reset.
- If you select "00" in each color, it displays no color on the display.
- The display color may not change when you adjust only one of the colors.

Select color mode

- 1 Press COLOR to display "SEL-COLOR" while the power is on.
- 2 Within 4 seconds, turn VOLUME/MULTI JOG to select the color.
The selected color is automatically set after 4 seconds. It is also set when pressing ENTER within 4 seconds. In this case, "SET-COLOR" is displayed.

Function color mode

- 1 Hold down COLOR until "F-COLOR" is displayed.
- 2 Within 4 seconds, turn VOLUME/MULTI JOG to select the source.
The source name and color number flashes on the display.
- 3 Press ENTER.
The source name stops flashing.
- 4 Turn VOLUME/MULTI JOG to select the color.
- 5 Press ENTER.
"SET-COLOR" is displayed and the color number stops flashing.
- 6 Repeat steps 2 to 5 to set the colors for other sources.

Changing the color mode

- 1 Hold down COLOR until "ON COLOR" and "OFF COLOR" flash alternately.
"ON COLOR" and "OFF COLOR" flash after "-F-COLOR" is displayed.
 - ON COLOR: function color mode
 - OFF COLOR: select color mode
- 2 Release COLOR while the desired mode flashes.

Setting the clock

- 1 Press SHIFT+CLOCK on the remote control.
When the unit is turned off, you can also press **■** or ENTER.
- 2 Press **◀◀** or **▶▶** to set the time.
Each press changes the time in 1-minute steps.
Holding these buttons down will vary the time in 10-minute units.
If **◀◀** or **▶▶** is not pressed within 4 seconds, setting is canceled.
 - You can also turn VOLUME/MULTI JOG to the right to advance the time and to the left to move the time back. The speed with which the time changes varies according to how fast you turn VOLUME/MULTI JOG.
- 3 Press **■** or ENTER.
The time display stops flashing and the clock starts from 00 seconds.

To display the time while the power is on

Press SHIFT+CLOCK on the remote control.
The time will be displayed for 4 seconds.

To switch to the 24-hour standard

Display the time and press **■** within 4 seconds.
With each press, the clock alternates between 12- and 24-hour standard time.

Tip:

In the 12-hour standard, "AM12:00" indicates midnight and "PM12:00" noon.

If the clock display flashes when the unit is turned off



There has been a power interruption. Reset the clock.

PLAYING DISCS—PREPARATORY INFORMATION

Read the following information before playing discs.

Supported disc formats

This unit plays discs with the following logos.

DVDs (12 cm disc)	
Video CDs (VCDs) (8 cm disc/12 cm disc)	
Audio CDs (8 cm disc/12 cm disc)	

- The unit may not play a CD-R/RW disc recorded on personal computers or certain kinds of CD-R/RW recorders.
- Do not attach adhesive label, etc. to either side of a CD-R/RW disc, as doing so may cause malfunction.
- Do not load an unrecorded CD-R/RW disc. The disc may be damaged.
- Do not use irregular-shaped CDs.

Color system for DVDs and VCDs

This unit conforms to the NTSC color system. If the VCD of PAL color system is played, sometimes the picture is distorted.

DVD region code

This unit is designed and manufactured for playback of region "1" encoded DVD software. Region code appears on most DVD labels to indicate which type of player can play the disc.

- A DVD without a "1" or "ALL" on its disc label cannot be played on this unit. If you try to play such a disc, the message "REGIONAL CODE VIOLATION" will appear on the TV screen.
- Some DVDs may not be properly labeled with a region code, although they may in fact be region encoded and thus limited in its playback area.

Software dependent features of DVDs and VCDs

Since playback operations of DVDs and video CDs may be intentionally fixed by software manufacturers, some playback features of this player may not be available. For example, some DVDs may not allow the pressing of STOP, **◀◀**, **▶▶**, or other buttons at certain points in the disc. "⊘" appears on the TV screen if you press a button that cannot be used. Refer to the instructions supplied with the disc.

Subdivision of discs

Title (DVD only)

Largest subdivision of a DVD; a movie for video software, or an album for audio software.

Chapter (DVD only)

Sections within a title. A title is usually made up of several chapters.

Track (audio CD and VCD only)

Sections within an audio or video CD.

Scene (VCD with PBC only)

Sections within a VCD with the PBC function. Scenes are displayed in tiles on the menu screen, each with a scene number for easy selection.

Types of VCDs

Video CDs equipped with PBC (Version 2.0)

PBC (PlayBack Control) allows you to select and play back tracks via menu operations. High-resolution stills can also be played back if available.

Video CDs not equipped with PBC (Version 1.1)

These older types of VCDs are operated in the same way as audio CDs.

- In some cases, you may want to play back VCDs equipped with PBC with the PBC feature off. This is because some disc playback features can only be used for VCDs without PBC. See "Disabling PBC", page 16.

Copyright protection

It is forbidden by law to copy, broadcast, show, broadcast via cable, play in public, or rent copyright material without permission.

Copy protection signals are included in some DVD and VCD discs. If video recording equipment is connected directly or indirectly to the video output of this unit, picture noise may appear when playing back such discs. Recording of such discs made on a VCR will also have picture noise.

This product incorporates copyright protection technology that is protected by method claims of certain U.S. patents and other intellectual property rights owned by Macrovision Corporation and other rights owners. Use of this copyright protection technology must be authorized by Macrovision Corporation, and is intended for home and other limited viewing uses only, unless otherwise authorized by Macrovision Corporation. Reverse engineering or disassembly is prohibited.

PLAYING DISCS—BASIC PLAYBACK

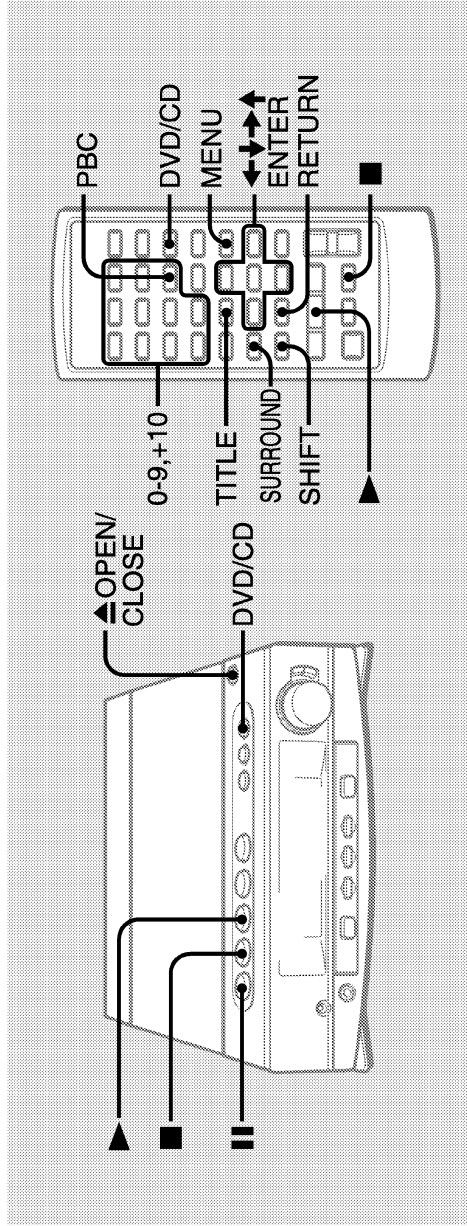

- Do not open or close the disc compartment forcibly by hand. If "LID ERR" is displayed, unplug the AC power cord and contact your AIWA dealer.
- Do not place more than one disc.
- Do not tilt the unit with a disc loaded.
- Do not touch the pickup lens. If it is soiled, discs may not be played normally.

To remove the disc

Press **▲** OPEN/CLOSE in stop mode to open the disc compartment. Then pull out the disc while pressing the center pivot.

To play DTS audio CDs

Hold down SURROUND to select "DTS MODE". "DTS CD MODE" lights up. Otherwise, high-level noise will be produced which may harm both your hearing and the unit.

Playing discs

Basic playback operation common to DVDs, audio CDs, and video CDs are described in this section.

Check your TV connection first

- Make sure the TV set is connected and its input source is selected properly.
- Various guide displays of the current operation are available on the TV screen. To view them, make sure you have "Guide Message ON" in the Setup menu (see "Guide Message", page 32).
- You can select the language for the guide message out of 3 available languages (see "Menu Language", page 32).

- 1 Press DVD/CD.
- 2 Press **▲** OPEN/CLOSE to open the disc compartment. Place a disc with the label side up. Then close the disc compartment.

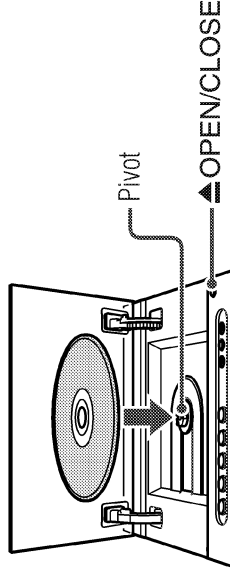

- 3 Press **▲**. For a DVD, or a VCD with PBC, playback starts automatically when the disc is loaded.

Playing back with the software specific menu (DVDs and VCDs only)

This unit supports the menu interface of DVDs, and VCDs with PBC. The menu screen may be displayed automatically when the disc is loaded.

Use the remote control.

DVDs

- 1 Press **↕** to select your desired program.
- 2 Press ENTER to begin playback.

To display the menu

Press TITLE or MENU during playback or stop.

VCDs

To select a program from the menu

Press the number button(s) to select your desired program.

To display the menu

Press RETURN.

- For some DVDs you can select the menu language out of the ones available. See "Disc Menu", page 33.
- Contents and operation of the software specific menu vary with the disc. Follow the instructions on the disc and on the menu screen.

Stopping and pausing

To stop playback

Press **■**.
The unit remembers the point at which playback stops. The unit remembers the point at which playback stopped.

To resume playback from the point where it stopped

Press **▶**.
"RESUME" appears on the TV display and playback starts where it last stopped (Resume function).

To clear the point to be resumed

Press **■** again during stop.
"RESUME OFF" appears on the TV display. The resume memory is cleared, and playback starts at the beginning of the disc when **▶** is pressed.

Notes on the resume function

- The point to be resumed is also cleared when the disc tray is opened, the current disc is switched, the power is turned off, or the function is switched.
- The resume function is not available for PBC playback of VCDs. To turn off PBC, see "Disabling PBC" below.

To pause playback

Press **⏸**.
To resume playback, press **▶**.

Disabling PBC (VCD only)

Press SHIFT+PBC on the remote control.
"PBC" disappears from the display, and the menu playback feature is disabled.

- With PBC disabled, VCDs are played just like audio CDs. This allows you, for example, to use repeat playback and programmed playback for VCDs with PBC.
- If PBC is pressed during playback, playback stops.
- See also "Types of VCDs", page 14.

PLAYING DISCS—SELECTING TRACKS/CHAPTERS

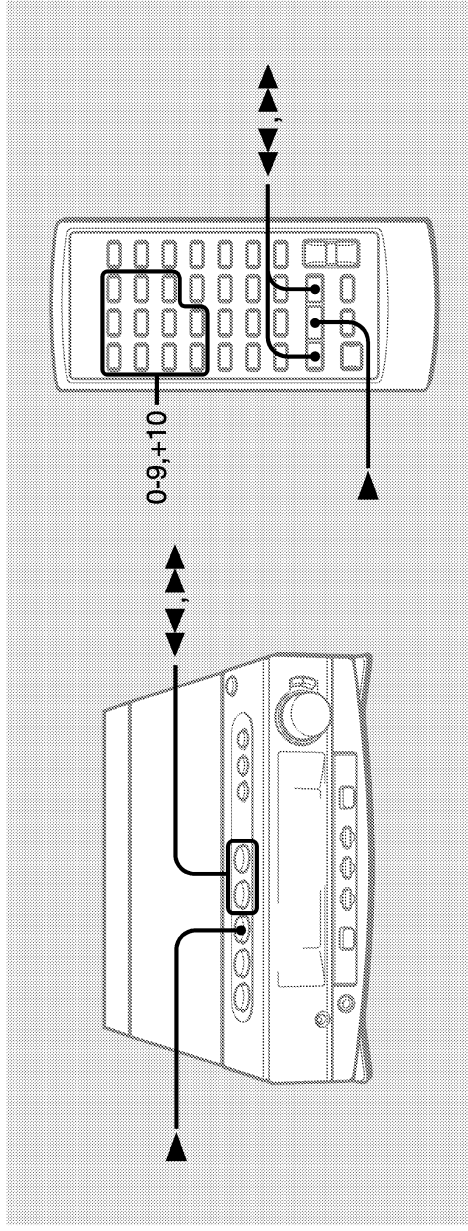

Skipping

- Press **◀◀** or **▶▶** repeatedly during playback.
- With each press of **▶▶**, the disc position skips to the beginning of the succeeding tracks (CDs/VCDs) or chapters (DVDs).
 - With each press of **◀◀**, the disc position skips back first to the beginning of the current track, then to the previous tracks (CDs/VCDs) or chapters (DVDs).
- Skipping may be disabled on some DVDs.

Basic operations to locate a desired point are described here. DVDs can also be searched by other methods (see "Playing discs—DVD features", page 20).

Direct selection (CDs and VCDs only)

Select a track directly by entering the track number on the remote control.

Press the numbered buttons for the desired track.

Example:

To play track 12, press +10, 2.

To play track 20, press +10, +10, 0.

Playback begins at the beginning of the selected track and continues to the end of the disc.

- For VCDs with PBC, turn off PBC first (see "Disabling PBC", page 16).

Fast forward/reverse playback

Hold down **◀◀** or **▶▶** during playback.

- DVDs: "**▶▶** x 2" or "**▶▶** x 2" is displayed on the TV screen.
- CDs and VCDs: "**◀◀** x 5" or "**▶▶** x 5" is displayed on the TV screen.

To change playback speed

Hold down **◀◀** or **▶▶** repeatedly.

- DVD: playback speed changes among double speed, 8 times and 32 times.
- CDs and VCDs: playback speed alternates between 5 times and 16 times.

To return to normal playback

Press **▶**.

- There is no audio during fast playback (DVDs and VCDs).
- Fast playback speed is the value for a disc with an average bit rate.

PLAYING DISCS—OTHER PLAYBACK MODES

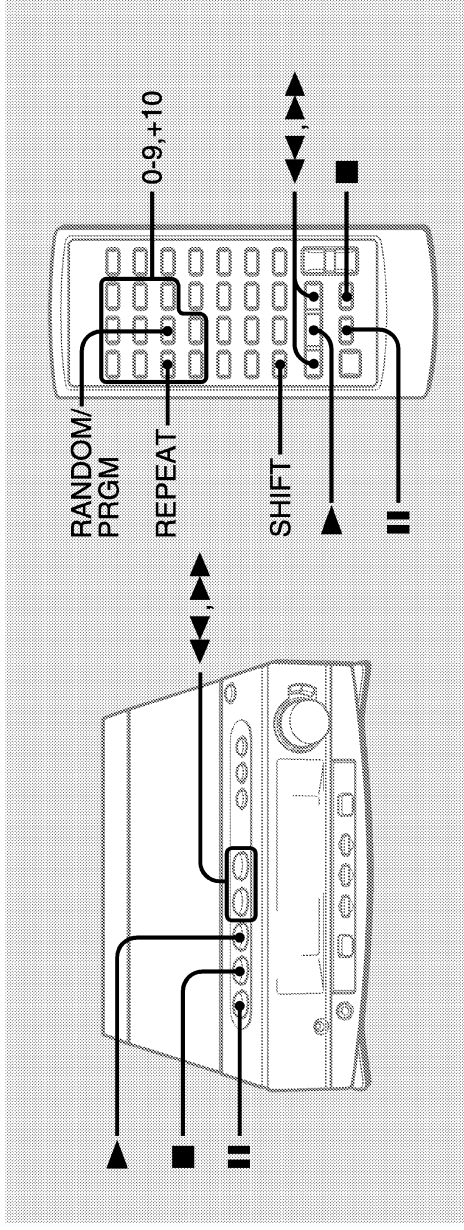

Repeat playback

DVDs

Press SHIFT+REPEAT repeatedly on the remote control during playback.

With each press, the repeat playback mode changes as follows:

- CHAPTER: repeats the current chapter.
- TITLE: repeats the current title.
- OFF: cancels repeat mode (normal playback)

"C" appears on the unit's display when the unit is in the title repeat mode and "C 1" appears in the chapter repeat mode.

CD and VCDs

1 Press SHIFT+REPEAT repeatedly on the remote control.

With each press, the repeat playback mode changes as follows:

- ALL: repeats all tracks on a disc.
- TRACK: repeats the current track.
- OFF: cancels repeat mode (normal playback)

"C" appears on the unit's display when the unit is in the all repeat mode and "C 1" appears in the track repeat mode.

2 Press **▶** to start playback.

- For VCDs with PBC, turn off PBC first (see "Disabling PBC", page 16).

To cancel repeat playback

Press SHIFT+REPEAT on the remote control repeatedly until "C" disappears on the unit's display.

To repeat playback of selected tracks

Program the tracks with the programmed playback function, and then press SHIFT+REPEAT to repeat playback of the programmed tracks.

Slow playback (DVDs and VCDs only)

1 Press **||** to pause playback.

2 Hold down **◀◀** or **▶▶**.

To change the slow forward playback speed

Hold down **▶▶** repeatedly.

The slow playback speed changes among 1/30, 1/15 and 1/5.

- Only 1/15 speed is available for slow reverse playback.

To return to normal playback

Press **▶**.

- There is no audio during slow playback.

Frame advance (DVDs and VCDs only)

1 Press **||** to pause playback.

2 Press **||** repeatedly to advance frames.

To return to normal playback

Press **▶**.

- There is no audio during frame advance.

Programmed playback (CDs and VCDs only)

Up to 30 tracks can be played back in the order of selection.

- 1 Press SHIFT+RANDOM/PRGM on the remote control in stop mode. "PROGRAM" appears on the TV screen and "PRGM" flashes on the unit's display.
- 2 Press the numbered button(s) on the remote control for the track to be played first. To select track 12, press +10, 2. To select track 20, press +10, +10, 0.
- 3 Repeat step 2 to program other tracks.
- 4 Press ► to start playback.

The programmed tracks are played back in the order of entry.

When programmed playback is complete or when ■ is pressed to stop playback, the program display reappears.

- For VCDs with PBC, turn off PBC first (see "Disabling PBC", page 16).
- During programmed playback, you cannot select a track with the numbered buttons.
- If the total playing time of the program exceeds 99 minutes and 59 seconds, the playing time is displayed as " : : : : :".

To stop programmed playback

Press ■. At this point, the program is not cleared. Pressing ► will restart programmed playback from the first programmed track.

To clear the program

Press ■ again during stop.

- The program is also cleared when the disc tray is opened, the function is switched or the power is turned off.

To check the program

Press ► during stop.

With each press, the program number and the track number are shown progressively on the unit's display.

To add tracks to the program

Repeat step 2 in stop mode. The new tracks are added to the end of the program.

To skip tracks

Press ◀ or ▶ repeatedly during playback.

Playback skips to the previous or the succeeding track(s) within the program.

Random playback (CDs and VCDs only)

Tracks can be played back randomly.

- 1 Press SHIFT+RANDOM/PRGM repeatedly on the remote control to display "RANDOM" on the unit's display.

"RANDOM" appears on the TV screen.

- 2 Press ► to start playback.

To cancel random playback

Press SHIFT+RANDOM/PRGM once on the remote control. "OFF" appears on the TV screen and "RANDOM" disappears on the unit's display.

- For VCDs with PBC, turn off PBC first (see "Disabling PBC", page 16).

Changing audio channels (VCDs)

Use this function when playing Karaoke VCDs or VCDs with different sound tracks in the left and right channels.

Press SHIFT+AUDIO SELECT repeatedly during playback.

With each press, the audio channel changes as follows:

- Lch: left audio channel is output from both front speakers
- Rch: right audio channel is output from both front speakers
- STEREO: normal stereo playback

- It is impossible to connect a microphone to this unit and sing along to music sources.

- Audio tracks of DVDs can also be switched. See "Changing audio tracks", page 21.

PLAYING DISCS—DVD FEATURES

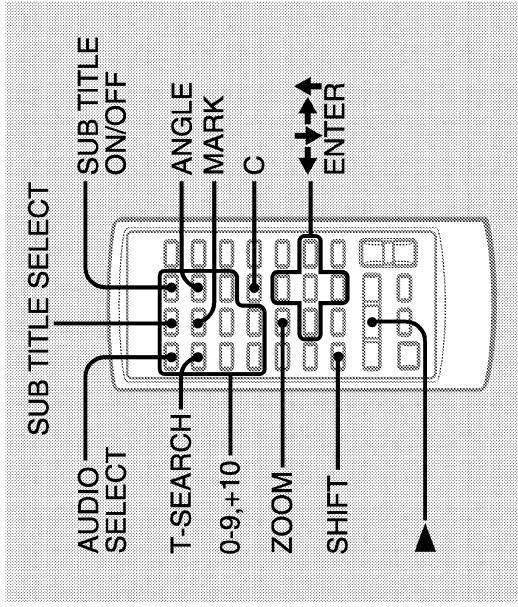

Features unique to DVDs, such as marking, searching, and switching of angles, subtitles, and audio tracks are described here.

Marking

Mark points in a DVD to be recalled later. You can mark up to 5 discs, each with up to 5 points.

- 1 Press **SHIFT+MARK** while playing back the desired point.
“P” appears on the TV screen and the unit enters the mark mode. The current mark memory is highlighted by the cursor.
- 2 Press **←→** if needed to move the cursor to the desired mark memory.
A numbered mark memory is occupied. An asterisk appears on a vacant one.
- 3 Press **ENTER**.
The current point is marked in the mark memory.
- 4 Press **SHIFT+MARK** again to exit the mark mode.

20

To recall a marked point

- 1 Press **SHIFT+MARK** to enter the mark mode.
- 2 Press **←→** to move the cursor or press a number button for the memory (1 - 5) to select the desired mark memory.
- 3 Press **ENTER** or **▶**.
Playback starts from the recalled point.

To clear a marked point

- 1 Press **SHIFT+MARK** to enter the mark mode.
- 2 Press **←→** to move the cursor or press a number button for the memory (1 - 5) to select the desired mark memory.
- 3 Press **C**.
- 4 Press **SHIFT+MARK** again to exit the mark mode.

• A marked point is recalled with the subtitle and audio language setting at the time it was marked, regardless of possible later changes to the setting.

- When the 6th DVD disc is inserted, the mark data for the oldest disc is overwritten by the disc information of the new disc and deleted, even when a new point is not memorized.

Title search

Specify the playback location of a DVD by the title number.

- 1 Press **SHIFT+T-SEARCH**.
 - 2 Press the numbered button(s) for the desired title number, or press **↑↓** to change the displayed title number.
Example:
To play title number 2, press 2.
To clear the number, press C.
 - 3 Press **ENTER** or **▶**.
Playback begins from the specified title.
- If you specify a title number which does not exist on the disc, the **⊖** symbol is displayed. Repeat from step 1 with a valid title number.

Chapter search

Specify the playback location of a DVD by the chapter number.

- 1 Press **SHIFT+T-SEARCH** twice.
- 2 Press the numbered button(s) for the desired chapter number, or press **↑↓** to change the displayed chapter number.
Example:
To play chapter number 7, press 7.
To play chapter number 20, press +10, +10, 0.
To clear the number, press C.
If needed, press **←→** to move the cursor to or from the title number.

3 Press ENTER or ▶.

Playback begins from the specified chapter.

- If you specify a chapter number which does not exist in the title, the **⊖** symbol is displayed. Repeat from step 1 with a valid chapter number.

Time search

Locate a point in the title by specifying the time from its beginning.

- 1 Press **SHIFT+I-SEARCH** 3 times while the resume function is activated or during playback.
- 2 Press the numbered buttons to enter the time for the desired point.
Example:
To specify 1:17:30 (1 hour 17 minutes 30 seconds), press 1, 1, 7, 3 and 0.
To specify 0:08:07 (8 minutes 7 seconds), press 8, 0 and 7.
To clear the numbers, press **C** repeatedly.

3 Press **ENTER** or **▶**.

Playback begins from the specified location.

- If you specify a time greater than the length of the title, the  symbol is displayed. Repeat from step 1 with a valid time.

Note on searching

- Title, chapter, and time search will not work with discs that do not support the search function.

Changing angles

Select the angle to view a scene when playing back DVDs shot with multiangles.

Press **SHIFT+ANGLE** repeatedly to select a viewing angle.

With each press, the angle will change. The current angle number and the number of available angles are displayed on the TV.

- If you press **SHIFT+ANGLE** when playing back a scene or a disc without multiple viewing angles, the  symbol is displayed.

Changing subtitles

Display the subtitles on the screen when playing DVDs which contain them. Subtitle language can be changed if more than one is available.

Press **SHIFT+SUB TITLE ON / OFF** during playback. The subtitles will be displayed. The current subtitle number and the number of available subtitles are displayed on the TV.

To change the subtitle language

Press **SHIFT+SUB TITLE SELECT** to select the desired subtitle language.

To turn off the subtitles

Press **SHIFT+SUB TITLE ON / OFF** again.

- If you press **SHIFT+SUB TITLE ON / OFF** when playing a disc without subtitles, the  symbol is displayed.
- The subtitle language can be changed only if the disc contains more than one subtitle language.
- Some discs have subtitles on by default and does not allow you to remove them.
- The subtitle language first displayed is specified by the subtitle setting (see "Subtitle Language", page 33).

Changing audio tracks

Some DVDs have more than one audio tracks, for example, soundtracks in different languages, or different sound mixes of the same recording. You can change the audio track when playing such discs.

Press **SHIFT+AUDIO SELECT** during playback.

Each time you press the button, the audio track will change. The current audio track number and the number of available audio tracks are displayed on the TV.

- The audio track can be changed only if the disc contains multiple audio tracks. The number of available audio tracks varies with the disc.
- The audio track language first played is specified by the audio language setting (see "Audio Language", page 32).

Listening Karaoke DVD discs

Press **SHIFT+AUDIO SELECT** repeatedly during playback to select your desired Karaoke track.

- It is impossible to connect a microphone to this unit and sing along to music sources.

Zoom

Press **SHIFT+ZOOM** during playback.

The picture around the center of the screen is enlarged to approximately 4 times.

To move the enlarged picture

Press **↑↓←→**.

To return to the center of the picture, press **C**.

To cancel zoom

Press **SHIFT+ZOOM** again.

PLAYING DISCS—STATUS DISPLAY

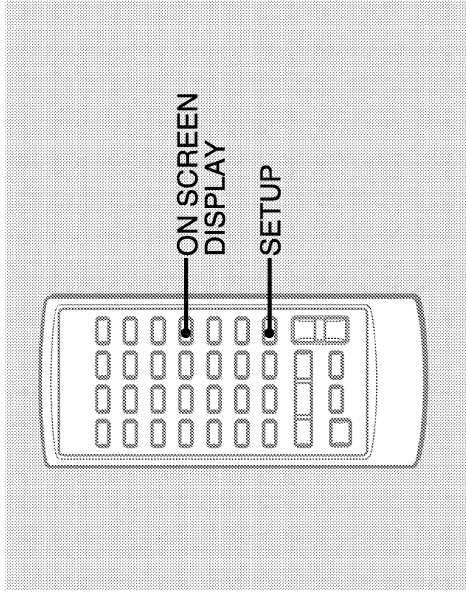

Various disc playback status information can be displayed on the unit's display and on the TV screen.

On the unit's display

Press SETUP repeatedly during playback.

DISPLAY on the unit is also available.

With each press, the playback time display changes as follows:

Audio and Video CDs

- Number and elapsed time of current track
- Number and remaining time of current track
- Elapsed time of disc
- Remaining time of disc

DVDs

- Number and elapsed time of current title
- Number and remaining time of current title
- Number and elapsed time of current chapter
- Number and remaining time of current chapter

• Playback time information cannot be changed during random playback.

• In some discs, playback time information may not be displayed correctly during programmed playback.

• Playback time information display is not available for VCDs with PBC.

On the TV

Press ON SCREEN DISPLAY repeatedly.

Various playback status information appear on the TV screen along with icons that indicate the type of information.

Common to all types of discs



shows the elapsed playing time during playback; total playing time or the playback resume point during stop



shows the repeat mode status

Audio and video CDs only



shows the track number



shows the program/ random playback mode status



shows if PBC is on or off (VCD only)

DVDs only



shows the title number and the chapter number



shows the type of audio track

DD: Dolby Digital signal. The numbers below indicate the number of front and rear audio channels.

For example,

"2/0" = [Conventional stereo] two front channels (left and right) and no rear channel

"3/2.1" [5.1-channel surround] = three front channels (left, right and center), two rear channels (left rear and right rear) and LFE (Low Frequency Effects).

dis: DTS signal.

LPCM: Linear PCM signal. The sampling frequency and the D/A conversion bits are displayed below, such as "48k-16b".

KARAOKE: Karaoke signal. The currently active vocal track is displayed below, such as "VOCAL 1 + 2".

MPEG: MPEG audio signal.



shows the current angle number out of the available number of angles



shows the current subtitle number out of the available number of subtitles



shows the occupied mark memory numbers

DOLBY AND DTS SURROUND

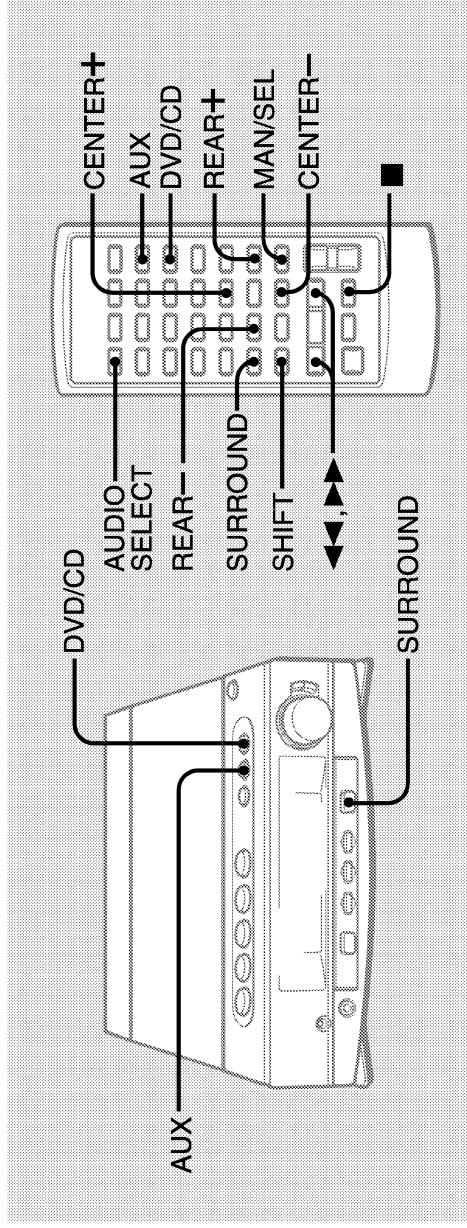

This unit comes equipped with a *Dolby Digital/Pro Logic decoder and a DTS decoder. With the full 5.1-channel speaker system supplied, Dolby and DTS surround sources can be played back in full scale home theater sound.*

Dolby and DTS surround

Dolby Digital and DTS are two different digital encoding systems of audio signals.

Both Dolby Digital and DTS, in their full configuration, can have a total of "5.1" discrete channels: left, center and right front channels, separate left and right surround channels, plus a low-frequency effects (LFE) channel, counted as "0.1" channel.

Dolby Digital and DTS tracks may also come in 1 or 2 channels (monaural or stereo, respectively), or in fact, any number of channels within the limit. Sources with 3 or more channels will be referred to hereon as a *multichannel* source.

Dolby Digital software is marked with the  logo.

DTS software is marked with the  logo.

Dolby Pro Logic is an analog audio encoding system with four independent channels: left, center, right, and surround. These four channels are coded into the two tracks of a conventional analog stereo source.

Dolby Pro Logic software is marked with the  logo.

• Make sure all supplied speakers are placed and connected properly (pages 5 to 7).

• Make sure your TV is connected properly and the appropriate input is selected.

Playing surround sources

1 Press DVD/CD and play the Dolby or the DTS surround disc.
DVDs may contain several audio tracks. If necessary, press SHIFT+AUDIO SELECT to select the desired playback track.

2 Press SURROUND.

The Dolby or the DTS decoder is enabled, depending on the source, and the source is played with the surround effect in the "NORMAL" listening mode.

The surround playback mode indicators light up according to the signal type and other conditions (see "Surround playback mode indication", page 24).

To play audio from external video equipment in surround sound

1 Press AUX and play the surround video source on the external equipment.

2 Press SURROUND.

To cancel surround playback

Press SURROUND repeatedly until "OFF" is displayed.

To adjust the sound level of the speakers during playback

See "To adjust the speaker level balance without the test signal", page 24.

• Dolby Digital, DTS, or the Dolby Pro Logic surround system is canceled when the headphones are plugged in.

• Dolby or DTS Surround sound can only be obtained when playing back a disc recorded in the respective system.

• To play DTS audio CDs, see "Playing discs", page 15.

Additional Dolby and DTS surround listening modes

In addition to the **NORMAL** mode, this unit is also equipped with the **PHANTOM** and the 3 **STEREO** modes.

- These modes are to be used when either the center speaker unit or the surround speaker units are not available, and therefore, not be needed under the normal use of this DVD system.

To change the listening mode

Press **SURROUND** repeatedly until the desired listening mode is displayed. With each press, the listening mode changes as follows:

- **NORMAL**
- **PHANTOM**: select this mode when no center speaker is connected. The center channel signals are output through the left and right speakers.
- **3-STEREO**: select this mode when no surround speakers are connected. The rear channel signals are output through the front speakers.
- **OFF**: select this mode when neither the center nor the surround speakers are connected. Multichannel Dolby Digital or DTS sources are played back in a 2-channel downmix.

Surround playback mode indication

The surround playback mode indicators light up on the display to show the actual surround playback mode.

- **“DOLBY DIGITAL”** shows that a multichannel Dolby Digital source is played back in surround sound.
- **“DOLBY PRO LOGIC”** shows that either a 2-channel source or a multichannel Dolby Pro Logic source is played back in surround sound.
- **“DOWNMIX”** shows that a multichannel source is played back in a 2-channel downmix.

Adjusting speaker level

For optimum performance, the sound level of all available channels should be adjusted to suit your listening environment.

The left and right front speakers create the stereo effect.

The center speaker helps achieve precise sound positioning over a broad sound field.

The surround speakers enhance the “depth” of the sound field.

Adjusting with the test signal

The unit is equipped with a built-in test signal generator for easy balance adjustment of the channels.

1 Press **SURROUND** repeatedly to select the mode for your speaker configuration.

- For playback with the supplied speakers, select “NORMAL”.

2 Hold down **SHIFT+MAN/SEL** on the remote control until “L” flashes in the display.

The test signal travels through the channels one by one. Indication for the currently adjustable channel flashes in the display:

- L: left front speaker
- C: center speaker
- R: right front speaker
- RS: right surround speaker
- LS: left surround speaker

3 Press **◀** or **▶** on the remote control to adjust the sound level.

- Left and right front speakers: press **◀** to shift the balance to the left and **▶** to shift to the right.
- Center and the surround speakers: press **◀** to de-emphasize the channel and **▶** to emphasize the channel.

Adjust the sound level so that the test signal from each channel is heard with the same loudness.

- The channel will not change while you are adjusting the sound level.

- A clicking sound might be heard with the test signal during level adjustment. This is not a malfunction.

To stop speaker level adjustment

Press **■** or **MAN/SEL**.

To adjust the speaker level without the test signal

- 1 Play the surround source.
- 2 Press **SURROUND** repeatedly to select the mode for your speaker configuration.
- 3 Press **SHIFT+MAN/SEL** repeatedly on the remote control until “L/R” is displayed.
- 4 Press **◀** or **▶** on the remote control to adjust the sound level of the front speakers.
- 5 Repeat steps 3 and 4 to adjust the sound level of the other speakers (S-W: subwoofer, C, RS, or LS).

- **SHIFT+CENTER +/-** and **SHIFT+REAR +/-** buttons are also available for the level adjustment of these channels. LS and RS channels cannot be adjusted separately with the **REAR** buttons.

- Speaker level adjustment is available only for speakers that are activated.

- Speaker level setting is common to Dolby Digital, DTS, and Dolby Pro Logic.



RADIO

Adjusting delay time

Sounds from the surround speakers and the center speaker are reproduced a split second after the front speakers for the effect of depth.

- 1 Play the surround source.
 - Delay time adjustment of the center channel is available only when playing Dolby Digital or DTS multichannel sources.
- 2 Press SURROUND repeatedly to select the mode for the speaker configuration.
- 3 Press SHIFT+MAN/SEL repeatedly on the remote control to select delay time to adjust.

- C_MS: delay time setting for center speaker
- S_MS: delay time setting for surround speakers

- 4 Press ◀◀ or ▶▶ on the remote control to adjust the delay time.

Center speaker: adjust the delay time so that screen dialogs are heard clearly and naturally, between 0 ms (milliseconds) and 5 ms in 1 ms steps. The default is "C 0MS" (no delay).

Surround speakers

Dolby Digital/DTS: adjust between 0 and 15 ms in 5 ms steps. The default is "S 5MS".
Dolby Pro Logic: adjust to 15 ms, 20 ms or 30 ms. The default is "S 20MS".

- Delay time setting in Dolby Digital/DTS affects that of Dolby Pro Logic, and vice versa.
- Delay time adjustment is available only for speakers that are activated.

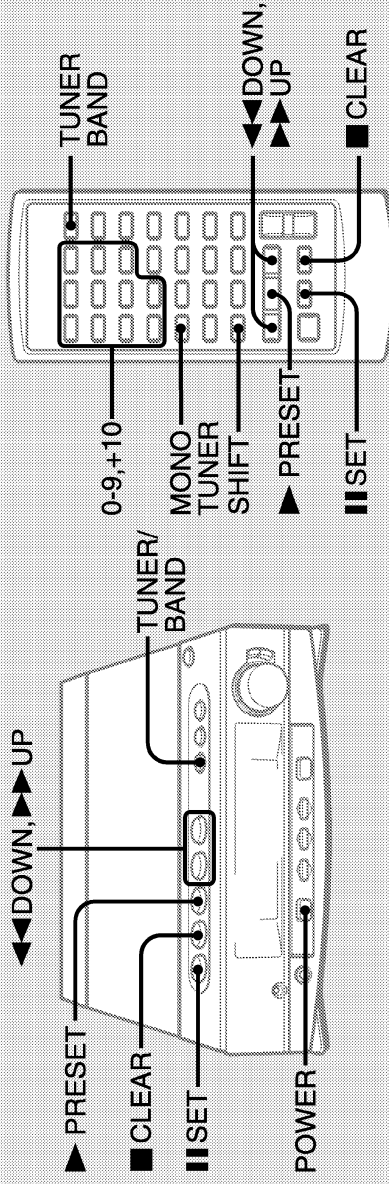

Manual tuning

- 1 Press TUNER/BAND repeatedly to select a band.
The unit switches to the radio from any other function and alternates between FM and AM.
- 2 Press ◀◀ DOWN or ▶▶ UP to tune in to a station.
"TUNE" is displayed when a station is tuned in.
"(())" lights up for FM stereo reception.

To search for a station automatically (Auto Search)

- Hold down ◀◀ DOWN or ▶▶ UP.
The unit searches for a station up or down the band and stops at reception.
To stop the search manually, press ◀◀ DOWN or ▶▶ UP.
- Auto Search may not stop at stations with weak signals.

Preset tuning

Preset your favorite stations and tune them in directly.

Presetting stations

- 1 Press TUNER/BAND to select the band.
- 2 Press ◀◀ DOWN or ▶▶ UP to tune in to the desired station.
- 3 Press II SET to store the station.
The preset number, beginning from "1", appears on the display.
- 4 Repeat step 1 to 3 to preset other stations.
 - You cannot store more than a total of 32 preset stations.
 - "FULL" is displayed.
 - If power is interrupted for more than approximately 12 hours, all settings stored in memory after purchase need to be reset.

Tuning in to preset stations

On the unit

- 1 Press TUNER/BAND to select the band.
 - 2 Press ► PRESET repeatedly.
With each press, the station with the succeeding preset number is tuned in.
- On the remote control
- 1 Press TUNER/BAND to select the band.
 - 2 Press the numbered button(s) for the preset number of your desired station.
 - To select preset number 20, press +10, +10 and 0.
 - To select preset number 15, press +10 and 5.► PRESET is also available.

To clear a preset station

- 1 Tune in to the station by preset tuning.
- 2 Press ■ CLEAR, then press ■ PRESET within 4 seconds.
Preset numbers of preset stations in the band with higher numbers decrease by one.

Adjustments

Antennas

Keep antennas away from metallic objects, electrical equipment and cords.

FM antenna: Extend fully in a T-shape. If receiving condition is poor, connect optional outdoor antenna to FM 75 Ω terminal. Be sure to connect the shield braid of the antenna to the  terminal.

AM antenna: Rotate to find best reception.

To switch to monaural FM reception

Press SHIFT+MONO TUNER on the remote control. With each press, "MONO" and "STEREO" are displayed alternately on the display.

- When FM stereo reception is poor, switching to monaural reduces noise.

To switch the AM tuning interval

Hold down TUNER/BAND and press POWER on the unit. With each press, the AM tuning interval alternates between 9 kHz/step and 10 kHz/step.

- The default is 10 kHz/step. Change it only when using the unit in a 9 kHz/step area. Switching AM tuning interval clears all the station presets.

SOUND

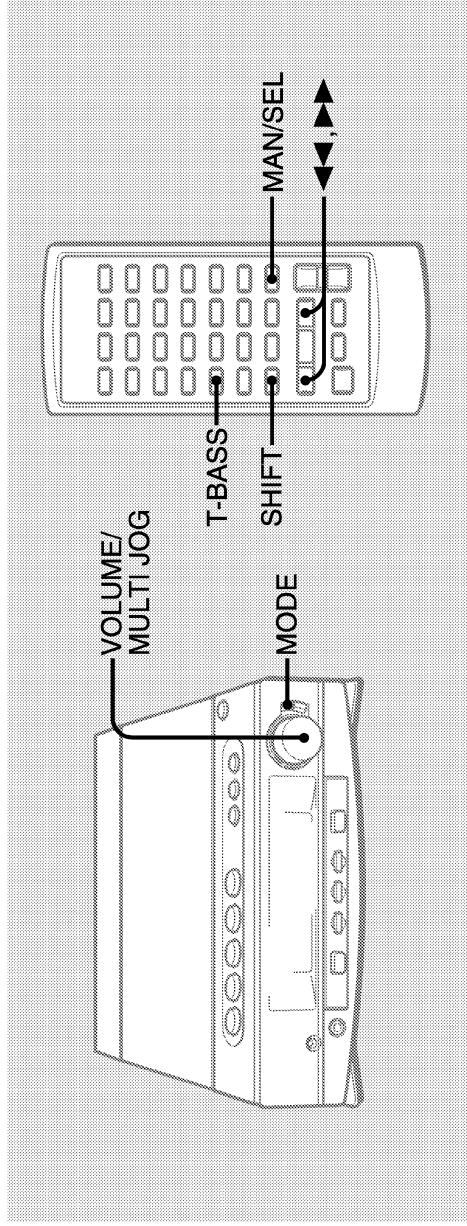

TREBLE

Adjusts the treble level.

- 1 Press MODE repeatedly to display "TREBLE".
 - 2 Within 7 seconds, turn VOLUME/MULTI JOG to adjust the treble level.
The treble level can be adjusted from "-5" to "+5".
- If the sound becomes distorted with the TREBLE effect, cancel the effect.

En

Adjusting left/right speaker balance

- 1 Press SHIFT+MAN/SEL repeatedly on the remote control until "L/R" is displayed.
 - 2 Press ◀◀ or ▶▶ on the remote control to adjust the balance.
Press within 4 seconds.
- When surround playback is activated, level adjustment of other speaker channels is available as well. See "Adjusting speaker level", page 24.

T-BASS

Emphasizes low frequencies for a powerful sound.

On the main unit

- 1 Press MODE repeatedly to display "T-BASS".
- 2 Within 7 seconds, turn VOLUME/MULTI JOG to select one of the three emphasis levels or the off position.

On the remote control

Press T-BASS repeatedly to select one of the three emphasis levels or the off position.

- If the sound becomes distorted with the T-BASS effect, cancel the effect.

BASS

Adjusts the bass level.

- 1 Press MODE repeatedly to display "BASS".
 - 2 Within 7 seconds, turn VOLUME/MULTI JOG to adjust the bass level.
The bass level can be adjusted from "-5" to "+5".
- If the sound becomes distorted with the BASS effect, cancel the effect.

TIMER

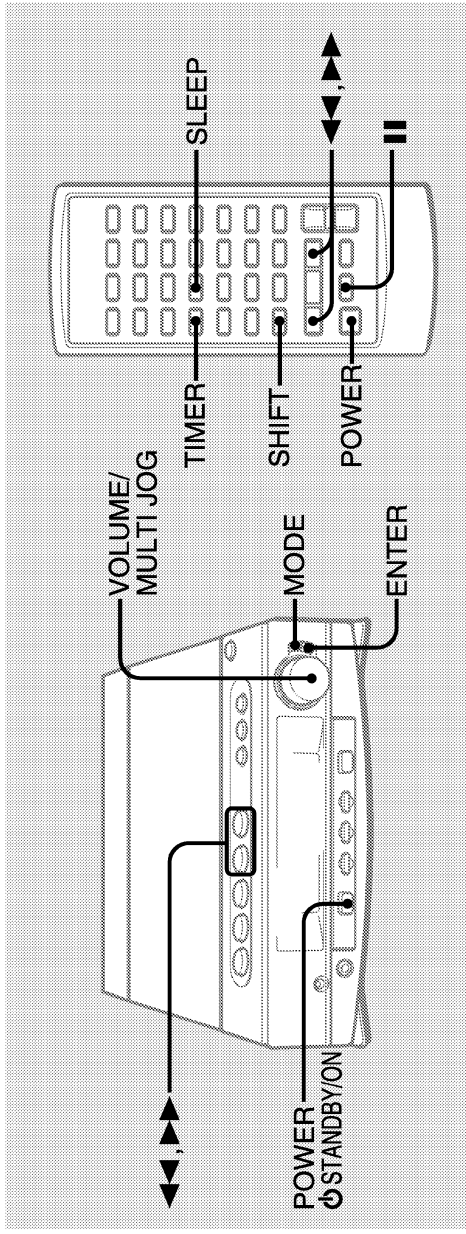

4 Press ◀▶ or ▶▶ to set the timer-on time, then press ENTER or ■.

5 Press ◀◀ or ▶▶ to set the timer-activated duration, then press ENTER or ■. With each press, the timer-activated duration changes in 5-minute steps between 5 to 240 minutes. If there is no button input for 4 seconds, the current setting is entered automatically.

- VOLUME/MULTI JOG is also available in place of ◀◀ or ▶▶.

6 Adjust the volume and tone for timer playback. If the volume level is set to 21 or higher, it is automatically turned down to 20 when the unit is turned on by the timer.

7 Prepare the source.

To play the disc, insert a disc.

To play the radio, select the band and tune in the desired station.

To play external equipment connected to the AUX jacks, set an external timer for the equipment so that playback begins at the same time.

8 Press POWER ⏻ STANDBY/ON to turn the unit off.

"⏻" remains on the display to indicate the timer standby mode (when ECO mode is deactivated).

At timer-on time, the unit turns on and plays the selected source. After the specified timer-activated duration, the unit turns off again.

- Timer playback will not begin unless the unit is turned off first.

- Connected equipment cannot be turned on or off by the built-in timer of this unit. Use an external timer.

Timer playback

Turns on the unit at a specified time for the specified duration. Make sure the clock is set correctly.

- 1 Select the desired playback source.
- 2 On the main unit
 - 1 Press MODE repeatedly to display "⏻".
 - 2 Within 7 seconds, turn VOLUME/MULTI JOG to display "⏻ PLAY".

On the remote control

Press SHIFT+TIMER.

"⏻" indicator lights up and "⏻ PLAY" appears on the display. The timer-on time and the source name along with the timer-activated duration appear alternately on the display.

- 3 Within 4 seconds, press ENTER (■) on the remote control).

The timer-on time and the source name along with the timer-activated duration appear alternately on the display.

Sleep timer

Turns off the unit automatically after a specified time.

- 1 Press MODE repeatedly to display "SLEEP". On the remote control, press SHIFT+SLEEP.
- 2 Press ◀◀ or ▶▶ repeatedly to set the sleep timer duration. With each press, the timer duration changes in 5-minute steps between 5 to 240 minutes. If there is no button input while "SLEEP" is displayed, the current setting is entered automatically. The unit turns off after the selected time.
 - VOLUME/MULTI JOG is also available in place of ◀◀ or ▶▶.

To check the remaining time until the unit turns off

Press MODE repeatedly (press SHIFT+SLEEP on the remote control). The remaining time is displayed for 7 seconds.

To cancel the sleep timer

Follow steps 1 and 2 above (press SHIFT+SLEEP twice on the remote control) so that "SLEEPoFF" is displayed.

To check the timer setting

Press SHIFT+TIMER on the remote control.

The timer-on time, the source and the timer-activated duration are displayed for a while.

To change the timer setting

Reset the timer again.

To turn off the timer

On the main unit

Press MODE repeatedly to display "⏻ PLAY" and turn VOLUME/MULTI JOG to display "⏻ OFF". Then press ENTER. "⏻" disappears from the display.

On the remote control

Press SHIFT+TIMER repeatedly until "⏻ OFF" is displayed. "⏻" disappears from the display.

Tip:

Your timer setting is retained even if the timer is turned off. Next time the timer is turned on, you can change your previous setting, or simply use the same setting again.

EXTERNAL EQUIPMENT

Connection besides those described in section "Preparation" are described here.

- See section "Parts and controls" for illustration.
- Connecting cords for optional equipment are not supplied.
- Refer also to the operating instructions of the connected equipment.
- Consult your local Aiwa dealer for optional equipment.

AUX jacks

Accepts analog audio signal input from connected equipment.

Connect to the line output jacks of VCRs, LD players, turntables, etc. with an optional audio connecting cord with RCA phono plugs (red plug to R jack, white plug to L jack).

- By connecting the audio output of a VCR, you can play sound tracks of Dolby Pro Logic videos through this system in surround sound. See section "Dolby and DTS surround".
- When connecting a turntable, use one equipped with a built-in equalizer amplifier.

To select input to these jacks

Press AUX.

To change input level

- 1 Press AUX.
 - 2 Press ◀ DOWN or ▶ UP repeatedly.
The input level changes from "MIN" to "5" and "MAX".
- When the "OVER" level indicator lights up on the display, the input level is too high. Turn down the input level.

LINE OUT jacks

Outputs analog audio signals to connected equipment.

Connect to the line input jacks of audio equipment with an optional audio connecting cord with RCA phono plugs (red plug to R jack, white plug to L jack).

- Do not connect the same equipment to the LINE OUT jacks and AUX jacks of this unit. Noise will be generated by a signal loop which may damage the equipment.
- Connecting the LINE OUT jacks to a TV may cause noise on this unit, depending on the TV. Disconnect the LINE OUT jacks in such cases.
- When playing DTS CDs in the DTS mode, noise may be output at the beginning of playback.
- When playing/recording the DTS source through the equipment connected to the LINE OUT jacks, cancel the surround playback (See page 23).

DIGITAL OUT (OPTICAL) jack

Outputs digital audio signals to connected equipment.

Connect to the optical input jacks of digital audio equipment with an optional optical cord.

- Remove the dust cap  from the jack before connection. Reattach the cap when the jack is not used.

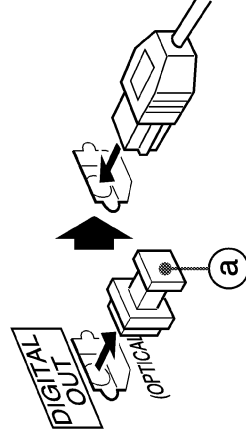

CAUTION!! When connecting to digital equipment without a Dolby Digital or a DTS decoder

NEVER play a multichannel Dolby Digital source through connected digital equipment without a Dolby Digital decoder.

Similarly, NEVER play a multichannel DTS source through connected digital equipment without a DTS decoder. Doing so will generate high level noise which may be harmful to your ears and damage the speakers.

- When recording a VCD through this jack, track numbers are not copied and one long track will be made.
- When a disc with 96 kHz sampling frequency rate is played back, output from the DIGITAL OUT (OPTICAL) jack is automatically converted to 48 kHz.

CUSTOMIZING DVD SETUP

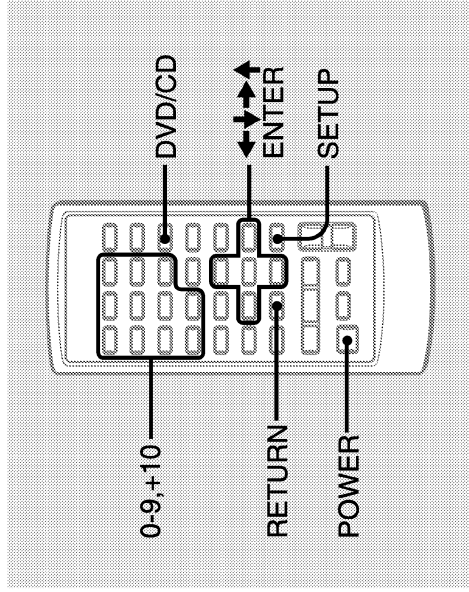

Ratings

Sets the rating limit of DVDs allowed to play back on this unit when playing discs with restriction level encoding.

The default "TV Aspect" setting has to be changed *if you are connecting to a 16:9 (wide) ratio TV set*. Any other setting can be changed or kept as is, according to your preferences.

Basic menu operation

Basic operation of the **SETUP MENU** is described here.

- 1 Press DVD/CD and press SETUP while the player is stopped.

The "SETUP MENU" screen is displayed.

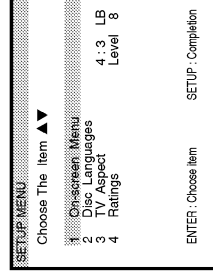

- 2 Press **↑↓** to move the cursor (the yellow-highlighted area) to the setting to be changed.

Various TV/DVD settings can be changed as needed or preferred.

- The language in which this menu is displayed can be selected from three available languages (see "Menu Language", page 32). The menu in English is used here for explanation.

Overview of the Setup Menu

There are 4 major menu items that can be adjusted:

On-screen Menu

- Sets the on-screen guide display on or off.
- Selects a background color for the TV screen.
- Selects the language for this setup menu and the on-screen guide messages.

Disc Languages

Selects the preferred audio soundtrack language, subtitle language, and menu language for DVD playback.

TV Aspect

Sets the aspect ratio of the video signal sent to your connected TV set.

- 3 Press **ENTER**.

The menu screen for the item you selected will be displayed.

- 4 Press **↑↓** to move the cursor to the desired setting.

- 5 Press **ENTER** to enter your selection.

The selected setting is entered and the display returns to the main setup screen of step 1.

For some settings, however, the screen will display a more detailed menu. Follow the directions shown on the screen.

- 6 Press **SETUP** to exit the setup menu.

To return to the previous screen

Press **RETURN**.

To exit the setup menu

Press **SETUP**.

To confirm your setting

- 1 Follow steps 1 to 4 above to display the setting you want to confirm.
- 2 Press SETUP to exit the setup menu without making changes.

- If you pressed RETURN or SETUP before pressing ENTER to enter your selection, you return to the previous screen or exit the setup menu, respectively, without entering your selection. If you are uncertain of your present setup, follow the steps above to confirm your setting.

- Your setting is not saved in the unit's memory until you press POWER to turn off the power. If the unit suffers a power interruption before it is turned off with POWER, setting will revert to the previous one when the unit is turned on the next time.

- While the setup screen is displayed, you will not be able to perform other operations on the DVD player. Press SETUP again to exit the setup screen first.

- Setup is canceled if the disc compartment is opened.

On-Screen menu

Set or select the on-screen guide display, background color for the TV screen, and the language for this setup menu and the on-screen guides.

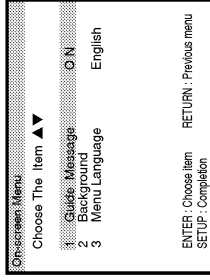

Guide Message

Sets whether or not to show the on-screen guide display at the upper right corner of the TV screen. The default is "ON".

- 1 Select "On-screen Menu" in the "SETUP MENU" and press ENTER.
- 2 Select "Guide Message" and press ENTER.
- 3 Select the desired setting and press ENTER.
- 4 Press RETURN to return to the previous screen or press SETUP to exit the setup menu.

Background

Sets the background color of the TV screen while stopped. The default is "Wallpaper".

- 1 Select "On-screen Menu" in the "SETUP MENU" and press ENTER.
- 2 Select "Background" and press ENTER.
- 3 Select the desired setting and press ENTER.
- 4 Press RETURN to return to the previous screen or press SETUP to exit the setup menu.

Menu Language

Selects the language in which this setup menu and the on-screen guide messages are displayed. The default is "English".

- 1 Select "On-screen Menu" in the "SETUP MENU" and press ENTER.
- 2 Select "Menu Language" and press ENTER.
- 3 Select the desired language and press ENTER.
- 4 Press RETURN to return to the previous screen or press SETUP to exit the setup menu.

Disc Languages

Selects the preferred audio sound track language, subtitle language and menu screen language for DVD playback.

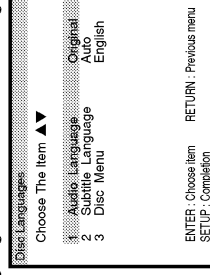

Audio Language

The default is "Original".

- 1 Select "Disc Languages" in the "SETUP MENU" and press ENTER.
- 2 Select "Audio language" and press ENTER.

3 Select the desired language and press ENTER.

- **"Original"**: plays discs in the language specified as the default on the disc. *Go to step 5.*
- **"English"**, **"French"**, **"Spanish"**: plays discs in the selected language. *Go to step 5.*
- **"Others"**: language code setting screen appears to select any other preferred language. *Go to step 4.*

4 If "Others" is selected in step 3, enter a four-digit language code with **↑↓** and numbered buttons, and press ENTER.

Refer to the list of language codes on page 35.

To move the cursor, use **←→**.

5 Press RETURN to return to the previous screen or press SETUP to exit the setup menu.

- If your preferred language does not exist on the disc, the disc's default language will be used.
- To manually change the audio tracks, see "Changing audio tracks", page 21.

Subtitle Language

The default is "Auto".

1 Select "Disc Languages" in the "SETUP MENU" and press ENTER.

2 Select "Subtitle Language" and press ENTER.

3 Select the desired language and press ENTER.

- **"Auto"**: automatically displays subtitles in the language specified in the "Audio Language" setting when needed; ex) when the "Audio Language" is set to English, no subtitles are displayed if current audio track is in English; if the audio track is in any other language, English subtitles are displayed.
- **"English"**, **"French"**, **"Spanish"**: shows subtitles in the selected language.

- **"Others"**: language code screen appears to select any other language. See step 4 of "Audio Language" setting.

4 Press RETURN to return to the previous screen or press SETUP to exit the setup menu.

- If your preferred language does not exist on the disc, the disc's default language will be used.
- To turn subtitles on or off, or to manually change the displayed subtitle language, see "Changing subtitles", page 21.

Disc Menu

The default is "English".

1 Select "Disc Languages" in the "SETUP MENU" and press ENTER.

2 Select "Disc Menu" and press ENTER.

3 Select the desired language and press ENTER.

- **"English"**, **"French"**, **"Spanish"**: shows the disc menu in the selected language.
- **"Others"**: language code screen appears to select any other language. See step 4 of "Audio Language" setting.

4 Press RETURN to return to the previous screen or press SETUP to exit the setup menu.

- If your preferred language does not exist on the disc, the disc's default language will be used.
- For the operation of the disc menu, see "Playing back with the software specific menu", page 16.

TV Aspect

Sets the aspect ratio of the video signal sent to your connected TV set.

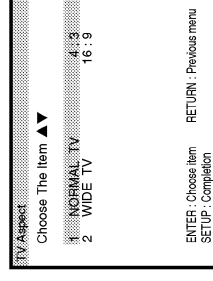

The default is "4:3 LB (letterbox)". If you are connecting to a 16:9 (wide) ratio TV set, change the setting to "Wide TV".

NORMAL TV

1 Select "TV Aspect" in the "SETUP MENU" and press ENTER.

2 Select "NORMAL TV 4:3" and press ENTER.

3 Select the preferred setting when playing a disc recorded in wide format, and press ENTER.

- **"LETTER BOX"**
The width of the picture is fit to the TV screen so that no part of the picture is cut off.
- **"PAN & SCAN"**
The left and/or the right portions of each scene are cut off as specified by the manufacturer, and the picture is displayed at full screen height.

4 Press SETUP to exit the setup menu.

- The preference setting for the 4:3 representation of wide format software is only effective when playing a disc offering such a choice. Such a disc may be labeled as "16:9 LB PS", where LB stands for "Letter Box" and PS for "Pan & Scan". Other discs, such as those labeled "16:9 LB" or "16:9 PS", are played according to the disc's setting, regardless of your preference.



WIDE TV

- 1 Select "TV Aspect" in the "SETUP MENU" and press ENTER.
- 2 Select "WIDE TV 16:9" and press ENTER.
- 3 Press SETUP to exit the setup menu.

Ratings

Sets the rating limit to play discs with restriction level encoding.

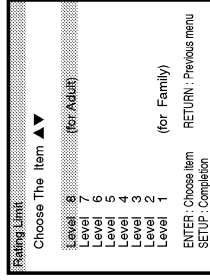

Setting the rating

The default is "Level 8".

- 1 Select "Ratings" in the "SETUP MENU" and press ENTER.
- 2 Select your desired level and press ENTER.
The smaller the number, the higher the level of restriction. For example, setting the rating level to 1 will restrict playback of all discs with a rating level from 2 to 8, either by cutting certain scenes or disabling playback altogether, depending on the disc. Check your disc for details.
- 3 Select the country code for your country.
The country code needs to be set correctly, since the rating system differs with the country.
When "Other Country" is selected in the country code, the display changes to accept 4-digit numbers. Input a 4-digit country code shown on page 36 in the same way as the input of the language code (page 33).

4 Press ENTER.

The password entry screen is displayed.

- 5 Use the numbered buttons and **↑↓** to enter a four-digit password, and press ENTER.
Confirm your password.

Do not forget your password!

If you forgot your password, reset the DVD setup (see "Resetting DVD setup", page 38) and re-set all settings again, including the "Ratings" setting.

- 6 After confirming the password, press ENTER again.

- 7 Press SETUP to exit the setup menu.

Changing the setting

Once the ratings settings have been set, you first need to enter the password to change them.

- 1 Select "Ratings" in the "SETUP MENU" and press ENTER.
- 2 Input your four-digit password and press ENTER.
- 3 Select the setting to be changed and press ENTER.
"Unlock Player" resets the rating level, country and password setting to default.
- 4 If you chose "Unlock player", the message "The player is unlocked" appears on the display. Press ENTER.
For other settings, change to your desired setting and press ENTER.
- 5 Press RETURN to return to the previous screen or press SETUP to exit the setup menu.

LANGUAGE CODES

Use these numbers to specify the language in the “Disc Languages” setting (page 32).

Code	Language	Code	Language	Code	Language	Code	Language	Code	Language
3738	Abkhazian	4246	Fiji	4850	Lingala	5545	Singhalese		
3737	Afar	4845	Finnish	4856	Lithuanian	5347	Slovak		
3742	Afrikaans	4254	French	4947	Macedonian	5548	Slovenian		
5553	Albanian	4261	Frisian	4943	Malagasy	5551	Somali		
3749	Amharic	4348	Galician	4955	Malay	4155	Spanish		
3754	Arabic	4737	Georgian	4948	Malayalam	5557	Sundanese		
4461	Armenian	4041	German	4956	Maltese	5559	Swahili		
3755	Assamese	4148	Greek	4945	Maori	5558	Swedish		
3760	Aymara	4748	Greenlandic	4954	Marathi	5648	Tagalog		
3762	Azerbaijani	4350	Guarani	4951	Moldavian	5643	Tajik		
3837	Bashkir	4357	Gujarati	4950	Mongolian	5637	Tamil		
4157	Basque	4437	Hausa	5037	Nauru	5656	Tatar		
3850	Bengali; Bangla	4559	Hebrew	5041	Nepali	5641	Telugu		
4062	Bhutani	4445	Hindi	5051	Norwegian	5644	Thai		
3844	Bihari	4457	Hungarian	5154	Oriya	3851	Tibetan		
3854	Breton	4555	Icelandic	5255	Pashto; Pushto	5645	Tigrinya		
3843	Bulgarian	4550	Indonesian	4237	Persian	5651	Tonga		
4961	Burmese	4537	Interlingua	5248	Polish	5654	Turkish		
3841	Byelorussian	4337	Irish	5256	Portuguese	5647	Turkmen		
4749	Cambodian	4556	Italian	5237	Punjabi	5659	Twi		
3937	Catalan	4637	Japanese	5357	Quechua	5747	Ukrainian		
6244	Chinese	4659	Javanese	5449	Rhaeto-Romance	5754	Urdu		
3951	Corsican	4750	Kannada	5451	Romanian	5762	Uzbek		
4454	Croatian	4755	Kashmiri	5457	Russian	5845	Vietnamese		
3955	Czech	4747	Kazakh	5549	Samoan	5851	Volapük		
4037	Danish	4761	Kirghiz	5537	Sanskrit	3961	Welsh		
5048	Dutch	4751	Korean	4340	Scots Gaelic	5951	Wolof		
4150	English	4757	Kurdish	5554	Serbian	6044	Xhosa		
4151	Esperanto	4851	Laothian	5544	Serbo-Croatian	4645	Yiddish		
4156	Estonian	4837	Latin	5550	Shona	6151	Yoruba		
4251	Faroese	4858	Latvian; Lettish	5540	Sindhi	6257	Zulu		

COUNTRY CODES

Use these numbers to specify the country in the "Ratings" setting (page 34).

Code	Country	Code	Country	Code	Country	Code	Country	Code	Country
6570	AFGHANISTAN	6678	BRUNEI DARUSSALAM	6971	EGYPT	7277	HEARD ISLAND AND MCDONALD ISLANDS		
6576	ALBANIA	6671	BULGARIA	8386	EL SALVADOR	7278	HONDURAS		
6890	ALGERIA	6670	BURKINA FASO	7181	EQUATORIAL GUINEA	7275	HONG KONG		
6583	AMERICAN SAMOA	6673	BURUNDI	6982	ERITREA	7285	HUNGARY		
6568	ANDORRA	7572	CAMBODIA	6969	ESTONIA	7383	ICELAND		
6579	ANGOLA	6777	CAMEROON	6984	ETHIOPIA	7378	INDIA		
6573	ANGUILLA	6765	CANADA	7075	FALKLAND ISLANDS (MALVINAS)	7368	INDONESIA		
6581	ANTARCTICA	6786	CAPE VERDE	7079	FAROE ISLANDS	7382	IRAN (ISLAMIC REPUBLIC OF)		
6571	ANTIGUA AND BARBUDA	7589	CAYMAN ISLANDS	7074	FIJI	7381	IRAQ		
6582	ARGENTINA	6770	CENTRAL AFRICAN REPUBLIC	7073	FINLAND	7369	IRELAND		
6577	ARMENIA	8468	CHAD	7082	FRANCE	7376	ISRAEL		
6587	ARUBA	6776	CHILE	7088	FRANCE, METROPOLITAN	7384	ITALY		
6585	AUSTRALIA	6778	CHINA	7170	FRENCH GUIANA	7477	JAMAICA		
6584	AUSTRIA	6788	CHRISTMAS ISLAND	8070	FRENCH POLYNESIA	7480	JAPAN		
6590	AZERBAIJAN	6767	COCOS (KEELING) ISLAND	8470	FRENCH SOUTHERN TERRITORIES	7479	JORDAN		
6683	BAHAMAS	6779	COLOMBIA	7165	GABON	7590	KAZAKHSTAN		
6672	BAHRAIN	7577	COMOROS	7177	GAMBIA	7569	KENYA		
6668	BANGLADESH	6771	CONGO	7169	GEORGIA	7573	KIRIBATI		
6666	BARBADOS	6775	COOK ISLANDS	6869	GERMANY	7580	KOREA, DEMOCRATIC PEOPLE'S REPUBLIC OF		
6689	BELARUS	6782	COSTA RICA	7172	GHANA	7582	KOREA, REPUBLIC OF		
6669	BELGIUM	6773	COTE D'IVOIRE	7173	GIBRALTAR	7587	KUWAIT		
6690	BELIZE	7282	CROATIA	7182	GREECE	7571	KYRGYZSTAN		
6674	BENIN	6785	CUBA	7176	GREENLAND	7665	LAO PEOPLE'S DEMOCRATIC REPUBLIC		
6677	BERMUDA	6789	CYPRUS	7168	GRENADA	7686	LATVIA		
6684	BHUTAN	6790	CZECH REPUBLIC	7180	GUADELOUPE	7666	LEBANON		
6679	BOLIVIA	6875	DENMARK	7185	GUAM	7683	LESOTHO		
6665	BOSNIA AND HERZEGOVINA	6874	DJIBOUTI	7184	GUATEMALA	7682	LIBERIA		
6687	BOTSWANA	6877	DOMINICA	7178	GUINEA	7689	LIBYAN ARAB JAMAHIRIYA		
6686	BOUVET ISLAND	6879	DOMINICAN REPUBLIC	7187	GUNEA-BISSAU	7673	LIECHTENSTEIN		
6682	BRAZIL	8480	EAST TIMOR	7189	GUYANA	7684	LITHUANIA		
7379	BRITISH INDIAN OCEAN TERRITORY	6967	ECUADOR	7284	HAITI	7685	LUXEMBOURG		

Code	Country	Code	Country	Code	Country	Code	Country	Code	Country	Code	Country
7779	MACAU	7885	NIUE	8367	SEYCHELLES	8571	UGANDA				
7771	MADAGASCAR	7870	NORFOLK ISLAND	8376	SIERRA LEONE	8565	UKRAINE				
7787	MALAWI	7780	NORTHERN MARIANA ISLANDS	8371	SINGAPORE	6569	UNITED ARAB EMIRATES				
7789	MALAYSIA	7879	NORWAY	8375	SLOVAKIA	7166	UNITED KINGDOM				
7786	MALDIVES	7977	OMAN	8373	SLOVENIA	8583	UNITED STATES				
7776	MALI	8075	PAKISTAN	8366	SOLOMON ISLANDS	8577	UNITED STATES MINOR OUTLYING ISLANDS				
7784	MALTA	8087	PALAU	8379	SOMALIA	8589	URUGUAY				
7772	MARSHALL ISLANDS	8065	PANAMA	9065	SOUTH AFRICA	8590	UZBEKISTAN				
7781	MARTINIQUE	8071	PAPUA NEW GUINEA	7183	SOUTH GEORGIA AND THE SOUTH SANDWICH ISLANDS	8685	VANUATU				
7782	MAURITANIA	8089	PARAGUAY	6983	SPAIN	8665	VATICAN CITY STATE (HOLY STATE)				
7785	MAURITIUS	8069	PERU	7675	SRI LANKA	8669	VENEZUELA				
8984	MAYOTTE	8072	PHILIPPINES	8368	SUDAN	8678	VIET NAM				
7788	MEXICO	8078	PITCAIRN	8382	SURINAME	8671	VIRGIN ISLANDS (BRITISH)				
7077	MICRONESIA (FEDERATED STATES OF)	8076	POLAND	8374	SVALBARD AND JAN MEYEN	8673	VIRGIN ISLANDS (U.S.)				
7768	MOLDOVA, REPUBLIC OF	8084	PORTUGAL	8390	SWAZILAND	8770	WALLIS AND FUTUNA ISLANDS				
7767	MONACO	8082	PUERTO RICO	8369	SWEDEN	6972	WESTERN SAHARA				
7778	MONGOLIA	8165	QATAR	6772	SWITZERLAND	8969	YEMEN				
7783	MONTSERRAT	8269	REUNION	8389	SYRIAN ARAB REPUBLIC	8985	YUGOSLAVIA				
7765	MOROCCO	8279	ROMANIA	8487	TAIWAN, PROVINCE OF CHINA	9082	ZAIRE				
7790	MOZAMBIQUE	8285	RUSSIAN FEDERATION	8474	TAJIKISTAN	9077	ZAMBIA				
7777	MYANMAR	8287	RWANDA	8490	TANZANIA, UNITED REPUBLIC OF	9087	ZIMBABWE				
7865	NAMIBIA	8372	SAINT HELENA	8472	THAILAND						
7882	NAURU	7578	SAINT KITTS AND NEVIS	8471	TOGO						
7880	NEPAL	7667	SAINT LUCIA	8475	TOKELAU						
7876	NETHERLANDS	8077	SAINT PIERRE AND MIQUELON	8479	TONGA						
6578	NETHERLANDS ANTILLES	8667	SAINT VINCENT AND THE GRENADINES	8484	TRINIDAD AND TOBAGO						
7867	NEW CALEDONIA	8783	SAMOA	8478	TUNISIA						
7890	NEW ZEALAND	8377	SAN MARINO	8482	TURKEY						
7873	NICARAGUA	8384	SAO TOME AND PRINCIPE	8477	TURKMENISTAN						
7869	NIGER	8365	SAUDI ARABIA	8467	TURKS AND CACOS ISLANDS						
7871	NIGERIA	8378	SENEGAL	8486	TUVALU						

REFERENCE

Care and maintenance

Occasional care and maintenance of the unit and the software are needed to optimize the performance of your unit.

To clean the cabinet

Use a soft and dry cloth. If the unit surfaces are extremely dirty, use a soft cloth lightly moistened with mild detergent solution. Do not use strong solvents such as alcohol, benzine or thinner.

Care of Discs

When a disc becomes dirty, wipe it from the center out with a cleaning cloth. After playing a disc, store it in its case. Do not keep it in hot or humid places.

Troubleshooting

If your unit fails to perform properly, check the following guide and the relevant sections of the Operating Instructions.

There is no sound.

- Check speakers and AC power connection.

The unit shuts off suddenly.

- Possibly a short circuit in the speaker terminals. Disconnect the AC power cord from the AC power outlet and re-connect the speaker cords correctly.

The unit blacks out when the unit is turned off.

- Check your ECO mode setting.

Erroneous display.

- Reset the unit.

Poor radio reception.

- Check antenna connection. Adjust the antenna to find the best reception.
- Move unit and antenna away from other electric appliances and cords.

The disc plays poorly (general).

- Check if the disc is correctly loaded.
- Check if the disc is not dirty.
- Check if the pickup lens is not affected by condensation. If so, wait approximately one hour and try again.

The disc plays poorly (DVDs).

- Check that the disc's rating level does not exceed your setting.
- Check that the disc is a NTSC color system disc.
- Check that the unit is not connected to a video deck, through a selector switch, or to a TV set with a built-in video deck. Picture noise may appear due to the DVD copy protection scheme. Turn off the power or disconnect these equipment.

- The picture quality may be poorer compared to normal playback during pause, frame advance, fast forward or fast reverse.

- Many DVD features, such as menu, subtitles, multi-audio, multi-angle, and rating are dependent on the DVD software itself. Check the instructions of your disc.
- If a multichannel source does not seem to be played with the full surround effect, check the type of your source (page 22), selected audio track (page 21), and selected listening mode (page 23 and 24).

Resetting the unit

If the display window gets mangled, reset the unit as follows:

- 1 Press POWER to turn off the power.
- If the power cannot be turned off, disconnect the AC power cord, then plug it in again.
- 2 Hold down **■** and press POWER.
- Everything stored in memory after purchase is cleared.

Resetting DVD setup

If trouble concerning DVD playback is not fixed with the troubleshooting tips mentioned above, or if you want to reset the DVD setup to default for any other reason, reset as follows:

- 1 Press DVD/CD.
 - 2 Press **■** to stop disc playback.
 - 3 Hold down ENTER and press **■**. Release when "CLEAR" appears on the unit's display.
- The power turns off automatically in a few seconds.
- 4 Press POWER to turn the power back on.
- All your setup menu setting is cleared to default. All mark data are erased.

Specifications

MAIN UNIT CX-LDV700

TUNER

FM tuning range 87.5 MHz to 108 MHz
FM usable sensitivity (IHF) 13.2 dBf
FM antenna terminals 75 ohms (unbalanced)
AM tuning range 530 kHz to 1710 kHz (10 kHz step)
531 kHz to 1602 kHz (9 kHz step)
350 µV/m
AM usable sensitivity Loop antenna
AM antenna

DISC PLAYER

Laser Semiconductor laser (DVD video discs $\lambda = 650$ nm, CDs $\lambda = 780$ nm)
90 dB (1 kHz, 0 dB)
0.05 % (1 kHz, 0 dB)
NTSC color system
Y output: 1 Vp-p (75 ohms, unbalanced)
C output: 0.286 Vp-p
Video composite output, 1 Vp-p (75 ohms, unbalanced), one RCA jack
5°C to 35°C (41°F to 95°F)

VIDEO OUT

Operating conditions

GENERAL

Input AUX: 400 mV
Output TO TS-LW700U: Din 8-pin
LINE OUT: 300 mV, 1 kohm
DIGITAL OUT (OPTICAL)
PHONES: 32 ohms or more
120 V AC, 60 Hz
25 W
ECO ON: 0.7 W
ECO OFF: 9 W
249 x 92 x 289 mm
(9 7/8 x 3 5/8 x 11 1/2 in.)
3.6 kg (7 lbs 15 oz)

SUB WOOFER TS-LW700

Input FROM CX-LDV700U: DIN 8-pin
Output FRONT: IMP. 8 ohms
CENTER: IMP. 8 ohms
SURROUND: IMP. 8 ohms

Power output

Front: 30 W + 30 W (40 Hz - 20 kHz, THD less than 1 %, 8 ohms)
37 W + 37 W (1 kHz, THD 10 %, 8 ohms)
Rear (Surround): 30 W + 30 W (40 Hz - 20 kHz, THD less than 1 %, 8 ohms)
37 W + 37 W (1 kHz, THD 10 %, 8 ohms)

Center:

30 W (40 Hz - 20 kHz, THD less than 1 %, 8 ohms)
37 W (1 kHz, THD 10 %, 8 ohms)

Subwoofer:

55 W (40 Hz - 200 Hz, THD less than 1 %, 6 ohms)
68 W (60 Hz, THD 10 %, 6 ohms)
Bass reflex type, (Magnetic shielded)
160 mm (6 3/8 in.)
40 Hz - 200 Hz

Speaker type

Speaker unit

Frequency response

Power requirements
Power consumption
Dimensions (W x H x D)

Weight

120 V AC, 60 Hz
170 W
220 x 383 x 450 mm
(8 3/4 x 15 1/8 x 17 3/4 in.)
12 kg (26 lb. 7 oz)

FIVE SURROUND SPEAKERS SYSTEM SX-L700

(Front, surround and center speakers)

Speaker system 1 way (magnetic shielded*)
Speaker units 80 mm (3 1/4 in.) cone
Impedance Front: 8 ohms
Surround: 8 ohms

Center: 8 ohms

Dimensions (W x H x D) 100 x 220 x 115 mm
(4 x 8 3/4 x 4 5/8 in.) (with pedestal)
100 x 110 x 115 mm
(4 x 4 3/8 x 4 5/8 in.) (without pedestal)

Weight 0.55 kg (1 lbs 3 oz)

Accessories: Wall mounting screws (5)

Anti-skid patches (9)

* The surround speakers are not magnetic shielded.

Specifications and external appearance are subject to change without notice.

DOLBY DIGITAL/DOLBY PRO LOGIC

Manufactured under license from Dolby Laboratories. "Dolby", "Pro Logic" and the double-D symbol are trademarks of Dolby Laboratories. Confidential unpublished works. ©1992-1997 Dolby Laboratories. All rights reserved.

DTS

Manufactured under license from Digital Theater Systems, Inc. US Pat. No. 5,451,942 and other worldwide patents issued and pending. "DTS" and "DTS Digital Surround" are trademarks of Digital Theater Systems, Inc. ©1996 Digital Theater systems, Inc. All rights reserved.

NOTE

This equipment has been tested and found to comply with the limits for a Class B digital device, pursuant to Part 15 of the FCC Rules. These limits are designed to provide reasonable protection against harmful interference in a residential installation.

This equipment generates, uses, and can radiate radio frequency energy and, if not installed and used in accordance with the instructions, may cause harmful interference to radio communications. However, there is no guarantee that interference will not occur in a particular installation. If this equipment does cause harmful interference to radio or television reception, which can be determined by turning the equipment off and on, the user is encouraged to try to correct the interference by one or more of the following measures:

- Reorient or relocate the receiving antenna.
- Increase the separation between the equipment and receiver.
- Connect the equipment into an outlet on a circuit different from that to which the receiver is connected.
- Consult the dealer or an experienced radio/TV technician for help.

CAUTION

Modifications or adjustments to this product, which are not expressly approved by the manufacturer, may void the user's right or authority to operate this product.

For assistance and information

call toll free 1-800-BUY-AIWA

(United States and Puerto Rico)

AIWA CO., LTD.
 <http://www.aiwa.co.jp>

Printed in Malaysia